

TRUCK / CV SPECIAL 2022



Das Werkzeug



NKW22/EN/XX/0

Valid from March 01, 2022 until February 28, 2023

We are commercial vehicles!



“
With the innovative specialty tools
from HAZET, you not only
save money, but lots of
time, too. They also take good
care of your materials.
”

Elif - Sales
Grew up using HAZET tools in
her father's haulage company.

4501-2, EAN-No. 4000896203499

Fuel and AdBlue® line pliers

- Simple operation of quick-release fasteners on fuel lines
- Volvo D13 · D16 · MAN D3876 LF · D1556 LF · D2676 LF and SCANIA engines
- CLAAS agricultural machinery with MAN engine
- AdBlue® lines and AdBlue® injection nozzles on agricultural machinery

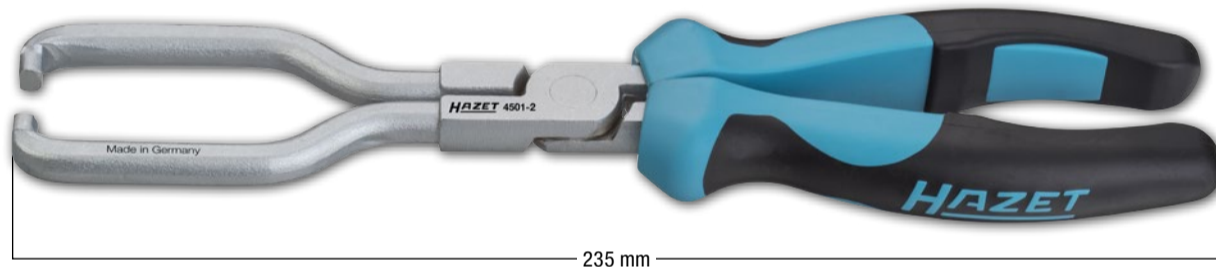

235 mm



Made in Germany

Problem solver!

1992-1, EAN-No. 4000896244270

Thermal camera

- Inspection of the engine compartment, the brake system and the cooling and heating system
- Application in building diagnostics, electrical installation, sanitary, air-conditioning and heating technology
- Colour palettes: White Hot, Black Hot, Rainbow, Ironbow
- Image sensor: Vanadium oxide uncooled focal plane arrays (FPA)
- Storage medium: exchangeable SD card 8 GB, up to 150,000 images
- Automatic hot, cold and central point measurement
- Laser pointer
- Including hand strap
- Screen size: 2.4" LCD screen
- Refresh rate: 25 Hz
- Screen resolution: 320 x 240 px
- Thermal (or IR) resolution: 160 x 120 px
- Thermal sensitivity (Noise Equivalent Temperature Difference, NETD): < 40 mK (0.04 °C)
- Field of vision: 37.2° x 50°
- Temperature measuring range: -20 °C to 550 °C (-4 °F to 1,022 °F)
- Measurement accuracy (max. ±2 °C, ±2 %):
Ambient temperatures: from 15 °C to 35 °C/
Object temperatures above 0 °C
- Protection rating: 54 IP
- Battery life: up to 8 hours (Li-ion rechargeable battery)
- Dimensions (H x W x D): 196 x 117 x 59 mm
- Weight: 0.35 kg

NEW!



**Laser pointer
for targeting!**

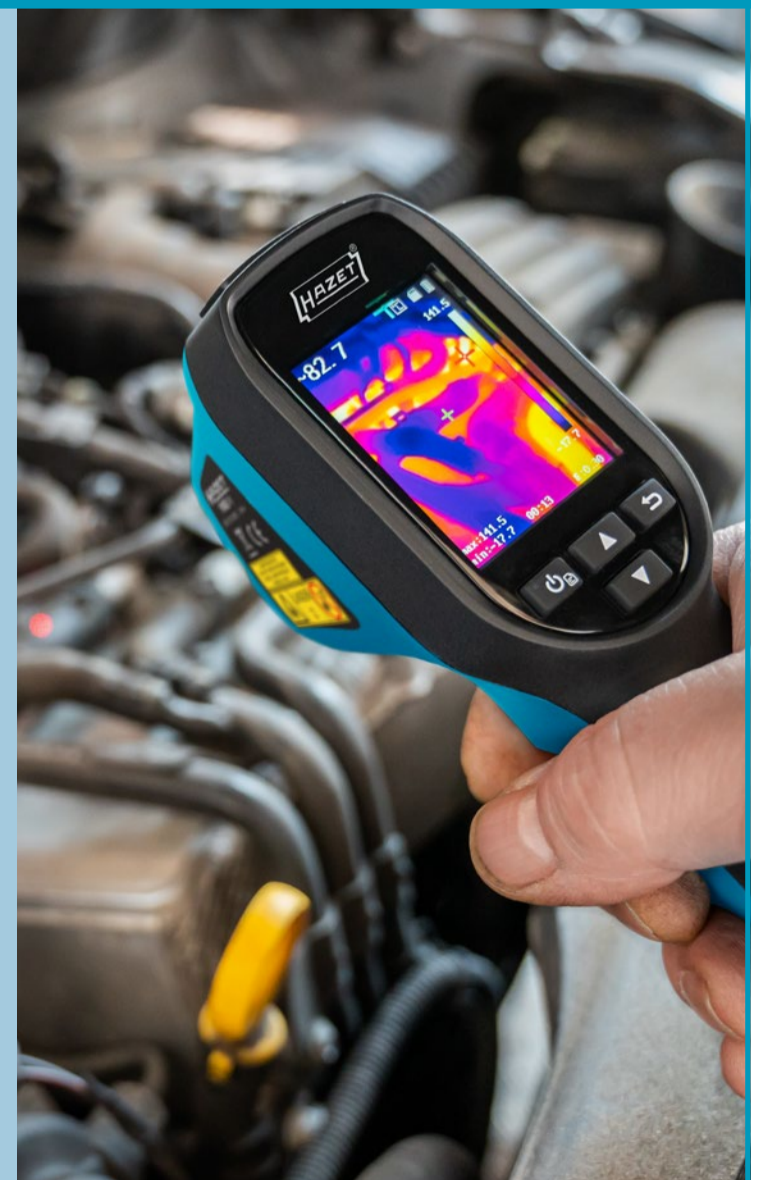

Exchangeable
SD card



Power supply: USB cable
(Micro USB)

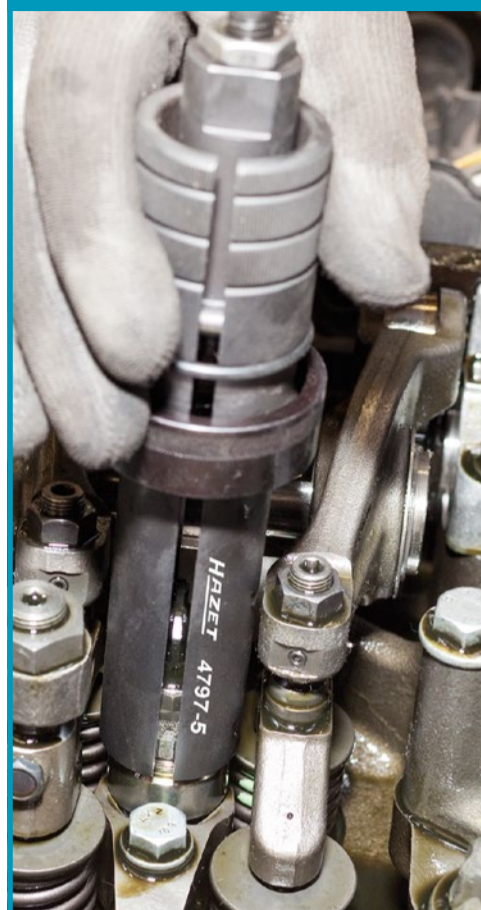

4797-5, EAN-No. 4000896176137

Injector extractor

- For disassembly of tight common rail injectors without removing the cylinder head
- For the simple removal of injectors together with sliding hammer, e.g. HAZET 1788T-1, on **MAN** engines D08, D20, D26 and D28
- Especially suited to the very limited space in the cylinder head
- Due to the tool's special claw, the injector may be gripped with caution, damage-free removal with the aid of the impact extractor
- Injector claw with inside thread M10 x 1.5 mm for insertion of the sliding hammer 1788T-1



174 mm

Made in Germany

1788T-1, EAN-No. 4000896134304

Sliding hammer

- With coupler thread M 10 (sliding weight 200 g)
- Together with injector extractor 4797-5
- Coupler thread M10
- Incl. union nut



266 mm

Made in Germany



Can only be used in combination with 1788T-1!



2850
3/4" TORX® impact socket

- For the operation of cylinder head bolts
- Long, reinforced design
- With borehole for locking pin or safety spring and groove for o-ring
- Surface: phosphatized, oiled



110 mm

Made in Germany

HAZET No.	mm	EAN-No. 4000896+
2850-E20	18.49	079681
2850-E24	22.16	146758

4550-21, EAN-No. 4000896204137
1/2" Injection line wrench DAF

- The special design of the socket ensures proper seat of the injection line fitting
- For the operation of the union nut on the high-pressure line on the injection valve common (rail injection system)
- Open 12-point socket for injection lines
- The tightening torque required by the manufacturer is achieved by using a HAZET torque wrench (observe manufacturer specifications)
- **DAF** Euro 6 engines MX11/MX13 e.g. XF, CF
- Surface: burnished



91 mm

Made in Germany



4550N-22, EAN-No. 4000896234387
1/2" Injection line wrench MAN

- The special design of the socket ensures proper seat of the injection line fitting
- Open 12-point socket for injection lines
- The tightening torque required by the manufacturer is achieved by using a torque wrench, for example, the HAZET 5120-3CT (observe manufacturer specifications)
- Output: outside double hexagon profile s 22 mm
- Surface: burnished



85 mm

Made in Germany

s 22 mm

4558, EAN-No. 4000896021888
1/2" Pressure nut crown wrench

- For the operation of the compression nut at the nozzle holder
- For **MAN** and **MERCEDES-BENZ** trucks M 401/421, M 402/422, LA, A, M 403/423, M 470h
- Outer/inner \varnothing : 28.4/23.5 mm
- Pin \varnothing : 7.8 mm
- Surface: chrome-plated



72 mm

Made in Germany

s 23.5 mm

4550-2, EAN-No. 4000896021734
1/2" Injection line wrench

- Open double hexagon socket
- For the operation of screw connections on injection lines e.g. for **MERCEDES-BENZ**
- Surface: chrome-plated

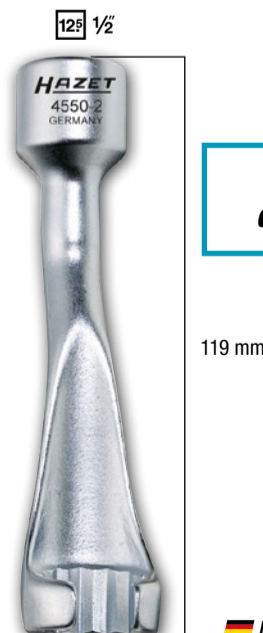

119 mm

Long design!

Made in Germany

s 19 mm

4550-3, EAN-No. 4000896104307
3/8" Injection line wrench

- Open 12-point socket for injection lines
- For the operation of screwed connections on injection lines e.g. for **MAN** trucks with D 20 engines – Common rail injection systems
- Surface: chrome-plated



83 mm

Made in Germany

s 17 mm

4800 Cooling pump and adapter

Made in Germany

HAZET No.	Components	EAN-No. 4000896 +
4800-1	<ul style="list-style-type: none"> Cooling pump Up to 2.5 bar 	022243
4800-2	<ul style="list-style-type: none"> Intermediary piece, flexible hose 	022274
4800-3	<ul style="list-style-type: none"> Amazona Pantera CLAAS Jaguar, Lexion, Scorpion, Ares, Atlas, Ceres DAF 45 model year 05/1991 → 12/2000 DOOSAN Wheel excavator S · Caterpillar excavator DX FENDT KAESER Mobilair LIEBHERR A308-316 MASSEY FERGUSON with tank no. 180224M92 and 4296015M1 MERCEDES-BENZ Vito · Viano · Solaris NISSAN forklifts PUTZMEISTER BSA 1409 SCANIA Vabis CASE Quadtrac, Magnum 	022281
4800-4A	<ul style="list-style-type: none"> DEUTZ Engines 3.6 PowerPack · BF6M1013FC · TCD2013L6 2V and 4V Genset 250kV HATZ 4H50tic IVECO Eco Daily with blue lock CASE Puma, SBS, LBS, Optum, Maxxum, CVX NEW HOLLAND TVT, T7, T7 Elite Pack, T6 FENDT Vario model year 2000 → Combine harvesters L series CLAAS Arion, Axion 	156504
4800-5A	<ul style="list-style-type: none"> COMPAIR Mobile compressor with VW expansion tank FENDT Farmer 300 model year 1988 → Type 500 · Type 700 · Vario model year 1988 → 2000 LINDE forklifts PUTZMEISTER BSA 1407D · BSA 2110 HP-D RENAULT Midium model year 01/2000 → 12/2013 Volvo FE model year 05/2006 → FL model year 03/2000 → 	161843
4800-16	<ul style="list-style-type: none"> DEUTZ Engines KHD1015 · D2008 · D2009 · TD2.9 L4 · TCD3.6 · BFM1013 · BFM2012 · TCD2013 2V · BFM1015 · TCD2015 V8 · V6 · M · TCD 12.0 and 16.0 MERCEDES-BENZ Sprinter model year 1999 → Type 170 · 208 · 611 	098507
4800-17	<ul style="list-style-type: none"> JOHN DEERE Tractors 5, 6, 7, 8 and 9 Series · Forage harvesters 8000 and 9000 Series · Self-propelled sprayer R4040, R4050, R4140 and 4150 · Windrower W170 · Cotton picker CP690 · Excavator 160DLC · Crawler dozer 700J · wheel loaders WL53, WL56 HITACHI excavator ZAXIS 6 HAGIE STS 10, 12, 14 and 16 	109661
4800-18	<ul style="list-style-type: none"> MERCEDES-BENZ Sprinter since 2006, Viano since 2003 	128815
4800-20	<ul style="list-style-type: none"> IVECO Euro-Star · Euro-Tech · Euro-Truck · Daily with black lock MAN F90 · F2000 · TGA model year 03/2000 → TGL model year 04/2005 → TGM model year 10/2005 → TGS model year 10/2007 → 01/2012 · TGX model year 10/2007 → 01/2012 MERCEDES-BENZ commercial vehicles Actros · Atego 1217 model year → 1999 · Eco 8401 · SK1728 · Antos · Arocs · Atego model year 1998 → 2013 · Axor model year 09/2001 → 10/2004 · Eonic · Zentros CLAAS Xerion, Tucano 	144242
4800-21A	<ul style="list-style-type: none"> Volvo commercial vehicles Scraper tractor dumpers 	162185
4800-23	<ul style="list-style-type: none"> ISUZU trucks MITSUBISHI commercial vehicle Fuso Canter NISSAN forklifts YALE GDP/GLP 16-30 	144273
4800-25	<ul style="list-style-type: none"> MAN buses such as Lions Coach · Lions Star · Lions Comfort · Lions City MERCEDES-BENZ Citaro model year 01/1998 	203857
4800-26	<ul style="list-style-type: none"> DAF CF and XF Euro 6 from 2013 	214495
4800-27	<ul style="list-style-type: none"> MERCEDES-BENZ Atego from model year 2014 	214501
4800-28	<ul style="list-style-type: none"> MERCEDES-BENZ Actros EURO 6 with HEYCO equalising tank from model year 2014 	214518
4800-29	<ul style="list-style-type: none"> SCANIA 143, G-/P- and R series 	222780



4800/8, EAN-No. 4000896216499

Radiator adapter case for commercial vehicles

- Checking for leakage in cooling systems and heating circuits
- 4800-1 Cooling pump to 2.5 bar
- 4800-2 Intermediary piece, flexible hose
- 4800-3 Radiator adapter for DAF 45 model year 05/1991 → 12/2000, DOOSAN Wheel excavator S, Caterpillar excavator DX, KAESER Mobilair, LIEBHERR A308-316, MERCEDES-BENZ Vito, Viano, Solaris, NISSAN forklifts, PUTZMEISTER BSA 1409, SCANIA Vabis
- 4800-5 A Radiator adapter for COMPAIR mobile compressor with VW expansion tank, LINDE forklifts, PUTZMEISTER BSA 1407D · BSA 2110 HP-D, RENAULT Midium model year 01/2000 → 12/2013, Volvo FE model year 05/2006 → FL model year 03/2000 →
- 4800-25 Radiator adapter for MAN buses such as Lions Coach, Lions Star, Lions Comfort, Lions City, MERCEDES-BENZ Citaro model year 01/1998, IVECO Euro-Star, Euro-Tech, Euro-Truck, Stralis, Daily with black lock, MAN F90, F2000, TGA model year 03/2000 →, TGL model year 04/2005 →, TGM model year 10/2005 →, TGS model year 10/2007 → 01/2012, TGX model year 10/2007 → 01/2012, MERCEDES-BENZ commercial vehicles Actros, Atego 1217 model year → 1999, Eco 8401, SK1728 Antos, Arocs, Atego model year 1998 → 2013, Axor model year 09/2001 → 10/2004, Eonic, Zentros
- 4800-26 Radiator adapter for DAF CF, XF Euro 6 model year 2013 →
- 4800-27 Radiator adapter for MERCEDES-BENZ Atego model year 2014 →
- 4800-28 radiator adapter for MERCEDES-BENZ Actros EURO 6 with HEYCO expansion tank model year 2014 →
- MAN TGX, TGS EURO 6 with HEYCO expansion tank model year 2012 →
- Classification to vehicle types: www.hazet.de → Service → The Tool Finder → Radiator adapters 4800



Made in Germany

4802-1, EAN-No. 4000896200030

Commercial vehicle vacuum radiator filler

- Fast cooling fluid flow rate: approx. 80 l in approx. 20 minutes
- No cooling fluid is lost through the cooling system overflowing
- Separate control through the diagnostic testing device is no longer necessary
- Vacuum leakage test before refilling the cooling system
- Bubble-free filling of the cooling and heating circuit in trucks, buses, agricultural machinery and construction vehicles
- Can be used together with single adapters (table: see above) or universal adapters e.g. HAZET 4801-2/3

80 litres in 20 minutes!



Made in Germany





2872-E

3/4" TORX® slogging wrench with 2 striking faces

- For loosening and tightening **TORX®** screws on brake calliper fittings on the front axle and trailing axles of trucks
- Use of the wrench for assembly and disassembly of the brake calliper fittings renders the disassembly of the steering tie lever unnecessary
- Correct tightening of screws with torque wrench using a 20 mm (3/4") drive in accordance with the manufacturer's specifications
- For e.g. **MAN TGL TGM** wrench sizes: E18, E20, E24
- **2872-E20** e.g. on **Schmitz Cargobull** Trailer axles

Wrench flat with laser-engraved formula for calculating the correct effective length!

Made in Germany

HAZET No.	Drive	l mm	g	Effective length mm	Head width mm	Head thickness mm	EAN-No. 4000896 +
2872-E18	E 18	215	573	120	30	12	201235
2872-E20	E 20	216	577	120	32	12	201242
2872-E24	E 24	219	588	120	38	12	201259

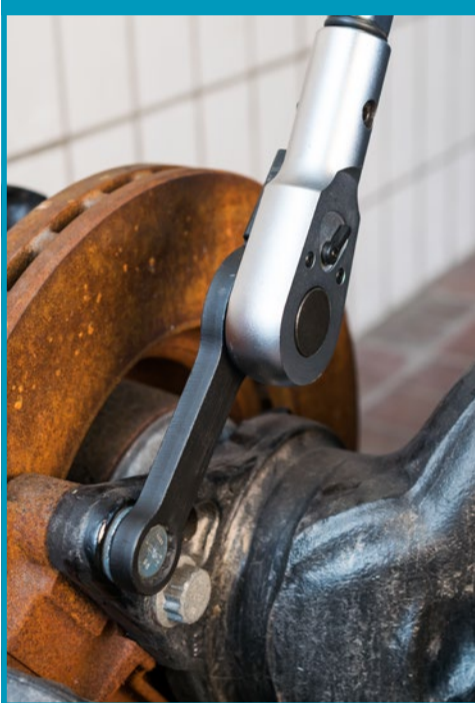

2872SZ

3/4" Commercial vehicle box-end wrench (12-point) with 2 striking faces

- 12-point profile facilitates application even on hard-to-reach fittings
- For e.g. **SAF**-brake calliper on **MERCEDES-BENZ** Atego and Actros
- Wrench with 20 mm (3/4") 4-point insertion hole for the correct tightening of screws with HAZET torque wrench in accordance with the manufacturer's specifications
- Wrench flat with laser-engraved formula for calculating the correct effective length

drive for torque wrenches!

Made in Germany

HAZET No.	For operation of the brake calliper screw connection on e.g.	mm	l mm	EAN-No. 4000896 +
2872SZ-24	SAF -brake calliper. MERCEDES-BENZ Atego and Actros	s 24	219.0	204175
2872SZ-26	DAF XF95/XF105/XF	s 26	219.0	203727
2872SZ-27	MERCEDES-BENZ Atego. Actros. KÄSSBOHRER buses	s 27	220.5	207183

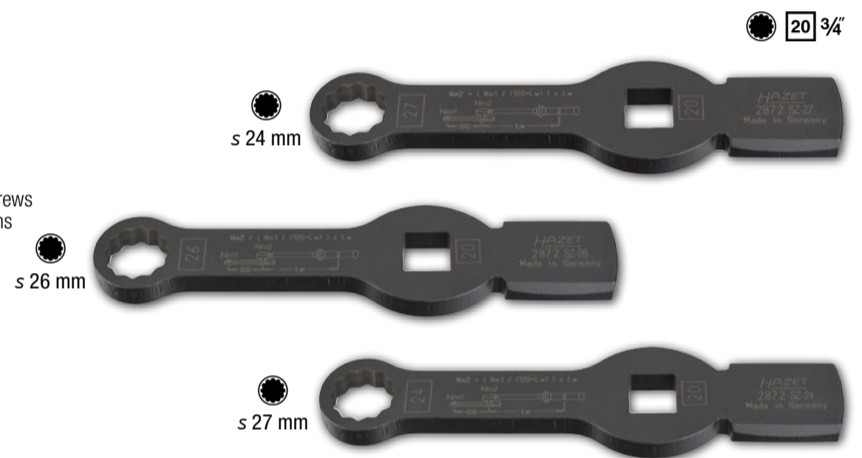

985S-14Lg/4, EAN-No. 4000896243686

Brake calliper screwdriver socket

- For the operation of the brake calliper screw connections (**KNORR-BREMSE**) on **MERCEDES-BENZ** trucks e.g. Actros, Arocs, Antos and buses such as e.g. Citaro, CapaCity Turismo, Intouro and Travego
- Operation of gearbox screw connections as well as screw connections is possible on frame and chassis
- Impact wrench operation is possible with e.g. HAZET 9013TT

NEW!



2784-14, EAN-No. 4000896155583

3/4" Brake calliper screwdriver socket

- For the operation of the brake calliper screw connections (**KNORR-BREMSE**) on **MERCEDES-BENZ** trucks e.g. Actros



4971-11, EAN-No. 4000896218257

Brake calliper resetting tool **KNORR-BREMSE**

- For operation of the readjusting tool on disc brakes **KNORR-BREMSE**
- For readjusting the brake calliper **KNORR-BREMSE** via nut-driver
- **Special 11 tooth profile**
- Suitable for brake callipers **KNORR-BREMSE** on trucks, buses, trailers and trailer axles of all brands

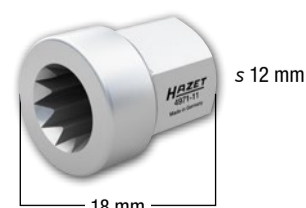

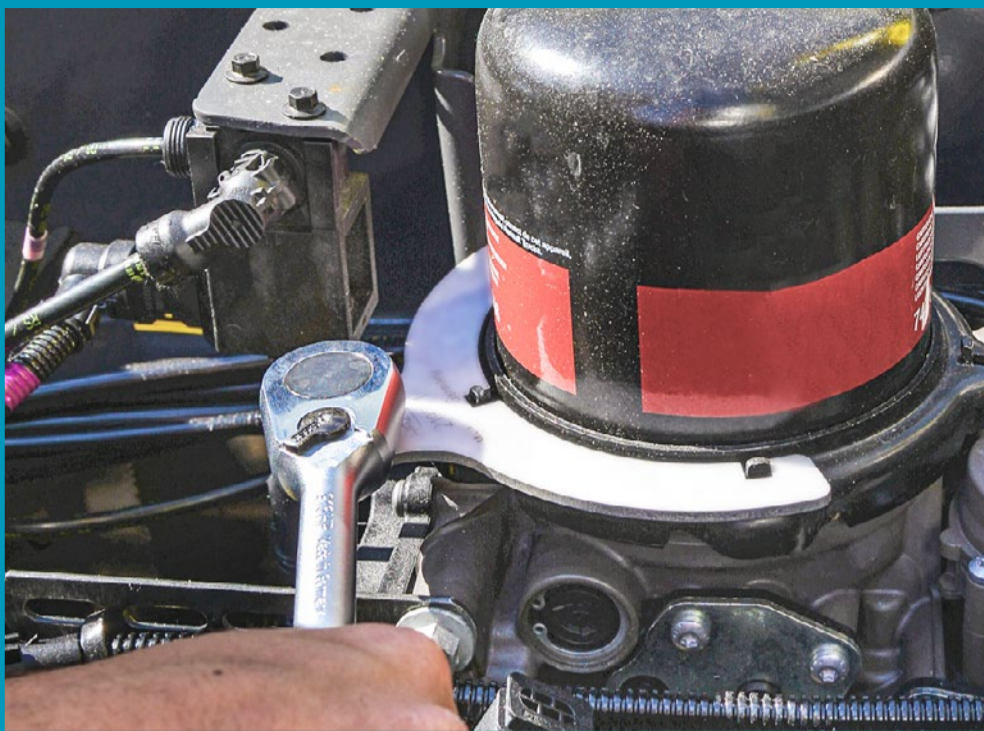

4971-12, EAN-No. 4000896232857

Brake resetting tool

- Resetting **WABCO** brake callipers without removing the brake cylinder
- Good accessibility of the resetting device
- Easy operation with the 3-component HAZET handle
- Operation with tried and tested HAZET ratchet wrench
- Special insert in the ratchet wrench ensures safe power transmission on the resetting device
- For **WABCO** brake calliper in **MERCEDES-BENZ** Actros, Antos, Arocs
- Adapter: s 8 mm



**Brake reset
made easy!**



 Made in Germany

2195-1, EAN-No. 4000896228898

1/2" Cartridge wrench

- The granulates cartridge with retaining ring is installed on **KNORR-BREMSE** air dryers with electronic parking brake (EPB) in **RENAULT** Trucks series T and C as well as in **Volvo** FH
- Torque-controlled tightening via integrated square 12.5 mm ($1/2$ " possible with e.g. HAZET torque wrench 5120-3 CT
- Operation of the granulates cartridge with retaining ring

 $1/2$ "

**Easy installation
and removal!**

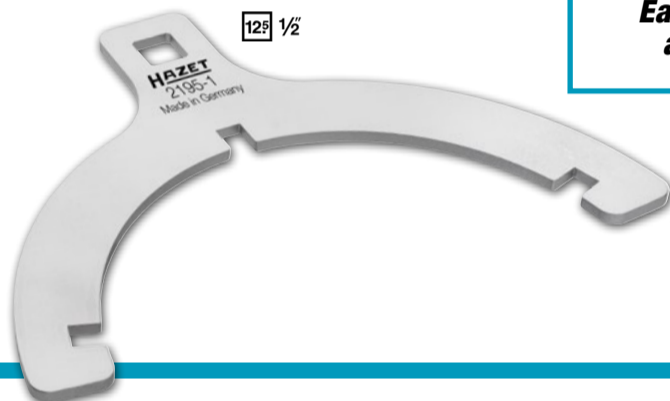

 Made in Germany

2872FS-24, EAN-No. 4000896209989

1/2" Commercial vehicle box-end wrench (12-point) with 2 striking faces

 $1/2$ "

- **No need to remove the wheel, even if brake cylinder fittings protrude far into the rim**
- Use in trucks, buses, trailers and trailer axles without removing the wheel
- **For loosening or tightening brake cylinder fittings**
- Laser-engraved formula for rapid conversion of the tightening torque specified by the manufacturer
- 2 impact areas enable the force to be applied using a hammer
- Time saving (approx.): 20 min

s 24 mm



**Brake cylinder disassembly
without removing the wheel!**

 Made in Germany



4969-612, EAN-No. 4000896204281

Compressed air quick-connector releasing tool

- **Easy loosening of quick-connectors with \varnothing 6, 8, 10, 12 mm**
- For operation with open-end s 13 mm (HAZET 600 N-13), no further tools necessary
- For plug connectors DIN 74324 6 x 1.0 · 8 x 1.0 · 10 x 1.0 · 12 x 1.5 · 12 x 2.0 mm
- Enables separating contaminated tubes and plug connectors
- To be used by one person
- Time saving and therefore also cost saving
- Prevention of injuries





 Made in Germany

2784-T60/4, EAN-No. 4000896188611

3/4" Screwdriver socket set for brake discs

 $3/4$ "

- For impact operation
- For the operation of the brake disc screw connections on **MERCEDES-BENZ** Actros

T60



$3/4$ "



 Made in Germany

2195, EAN-No. 4000896014101

1/2" Cartridge wrench

 $1/2$ "

- **For loosening the granulates cartridges**
- Forged design
- Negative position of arms
- **MAN** No. 8099606-0307
- Burnished, oiled surface
- Diameter (min. – max.): 90–140 mm
- Weight (net): 0.91 kg



 Made in Germany

Take care of your health – keep your back in good shape!

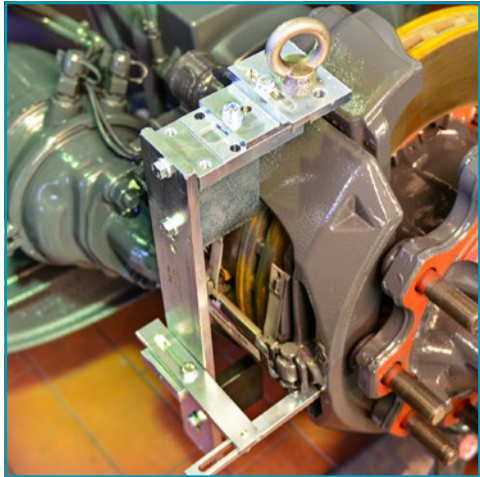

- ➔ **Suitable for all brake callipers and wheel hubs**
- ➔ **Brake calliper removal and installation with just one tool**
- ➔ **All brake service work can be carried out without straining your back**
- ➔ **Compatible with all brake callipers that have European type approval**

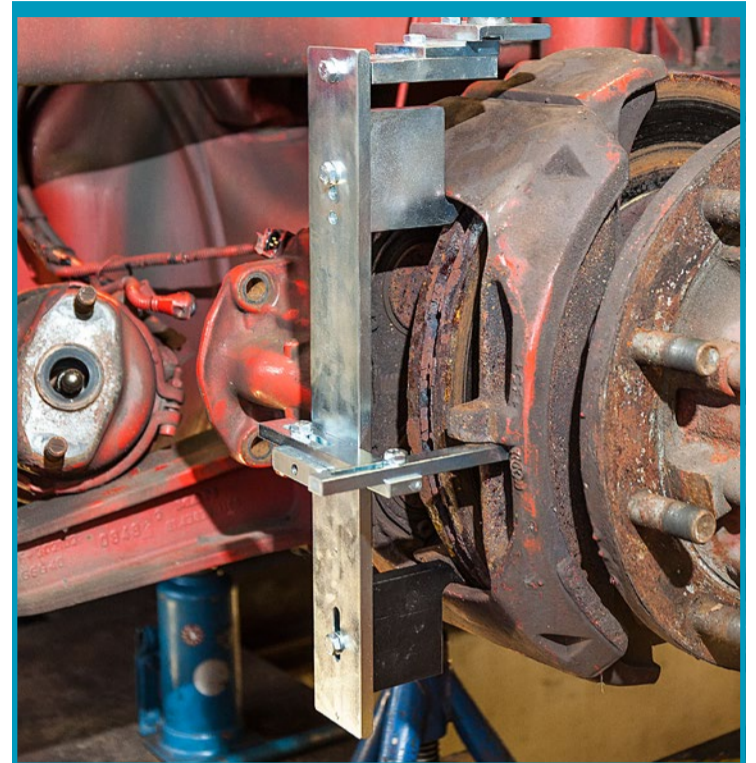
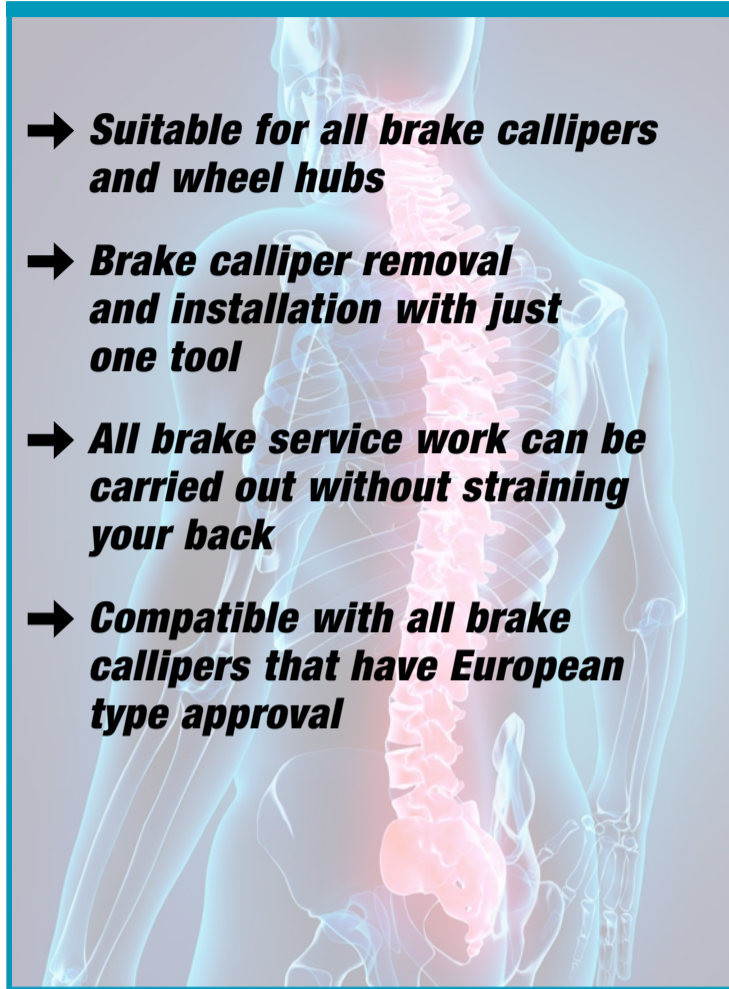

4972-1/3, EAN-No. 4000896215799

Brake calliper lifting aid

- Allows you to work safely, without straining your back, in tight spaces in the wheel arch on trucks, buses, trailers and trailer axles
- Significantly easier work when assembling and disassembling brake callipers and wheel hubs thanks to lifting aid
- No strain on the back
- Makes screw tightening easier
- Secure hold for heavy components
- Takes the various installation situations of the brake calliper into consideration
- Secure movement with suspended components
- One-hand operation possible via spindle
- Second person not required
- Setting range (min. – max.): 716–911 mm

Contents:

- Lifting aid
- Brake calliper holder
- Wheel hub holding tool



Made in Germany

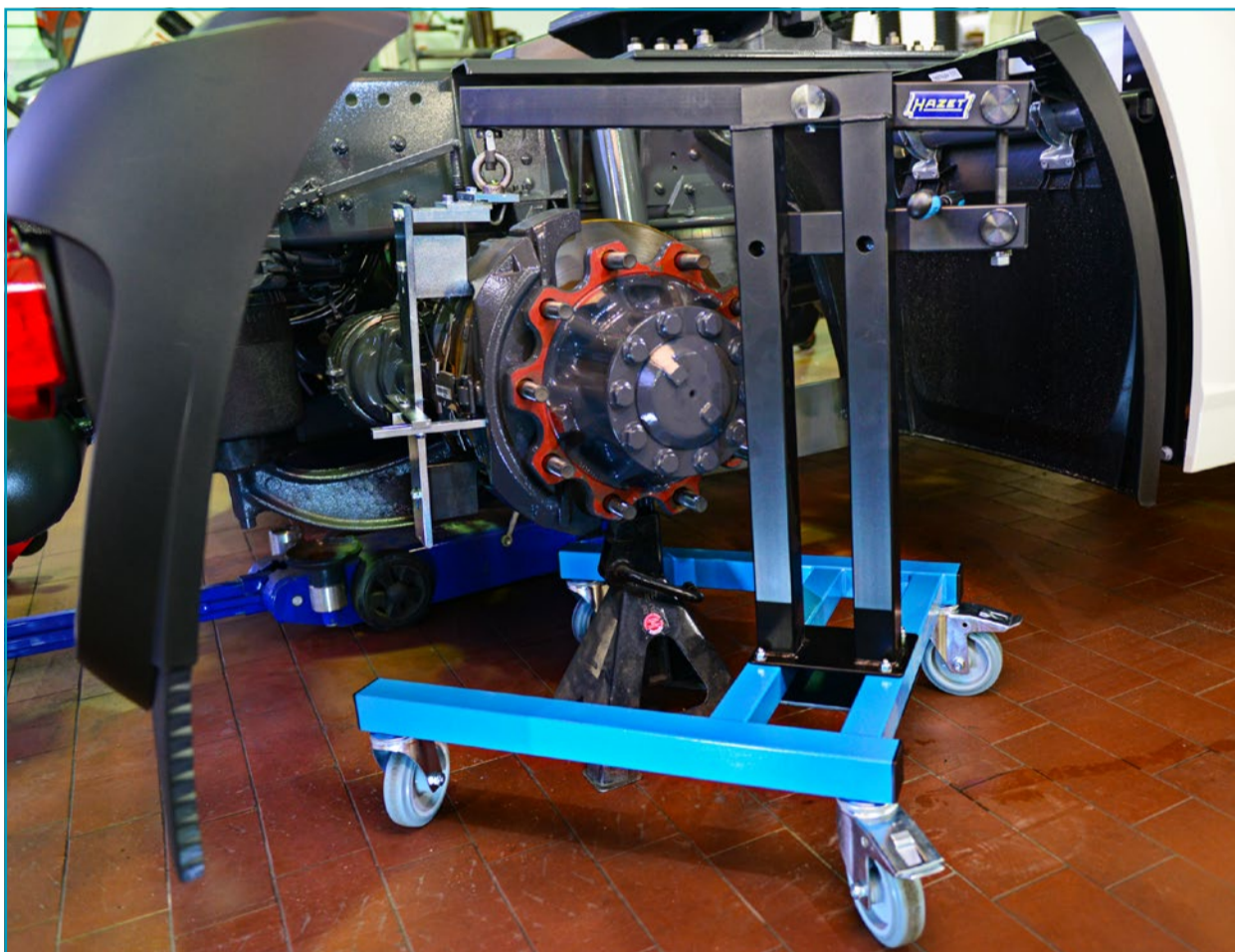

Together, a dream team!



4972-1, EAN-No. 4000896215423

Commercial vehicle brake calliper holder

- Allows you to work safely, without straining your back, in tight spaces in the wheel arch on trucks, buses, trailers and trailer axles
- Makes screw tightening easier
- Taking the various installation situations of the brake callipers into consideration
- Easy to use



Made in Germany

4972-2, EAN-No. 4000896215393

Swivel bearing

- For disassembly and assembly of brake calliper in trucks, buses, trailers and trailer axles that are installed in a diagonal "clockwise position between 8 o'clock and 5 o'clock"
- Connect swivel bearing to brake calliper holder and position with e.g. jacking carriage below brake calliper. This enables easy insertion of the screws even in awkward positions
- Together with brake calliper holder HAZET 4972-1



Made in Germany



“
Dimensional and fitting accuracy are of the utmost importance to us. When it comes to using specialty tools and large nut-drivers, we know how to play to our strengths.
 ”

*Thomas - Member of the Production Team
 Relies on his HAZET tools for converting machines and units in his work on the production team.*



4937-111/2, EAN-No. 4000896201945 25 1" 60 2

1" MAN commercial vehicle pin wrench set for rear axle

- For **MAN** TGX, TGA, TGS e.g. rear axle: HY 1350
- 4-point drive: 25 mm (1") as well as outside 6-point: s 60 mm
- 6 pins, width: 11 mm
- Inside Ø: 134.5 mm
- Inside Ø (pin-pin): 118 mm
- Outside Ø: 148.5 mm

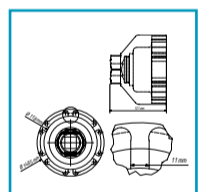

 Made in Germany

4937-80, EAN-No. 4000896199006 20 3/4"

3/4" Commercial vehicle axle nut socket, 8-point, s 80 mm

- For dismantling/assembling the front axle nut with 8-point in front of the brake disc
- **SCANIA** series R, series 4, series 124 I – 144 I – etc.
- Suitable for impact wrenches, e.g. HAZET 9013TT
- Precise fit
- Parallel surfaces for perfect force fit on axle nuts
- Solid design: high (shape) stability even with very high loosening or tightening torques



20 3/4"

 Made in Germany

4937-62, EAN-No. 4000896199020 20 3/4"

3/4" Commercial vehicle pin wrench for rear axle MERCEDES-BENZ

- Pin wrench for rear axle nuts
- **MERCEDES-BENZ** Actros, Atego (heavy design): LN2, SK rear axle
- With outside guide collar
- Inside Ø: 62.8/70 mm
- 6 inside pins, width of pins: 7.5 mm
- Length (total): 85 mm



20 3/4"

 Made in Germany

4937-92, EAN-No. 4000896201952 20 3/4"

3/4" Commercial vehicle pin wrench for front axle MAN

- Pin wrench for: **MAN** trucks: E 2000 (ÖAF), F 2000, M 2000 L, M 2000 M
- **MAN** TGA, TGM, TGS, TGX
- **MAN** buses: Lions City, Lions Classic, Lions Coach, Lions Regio, Lions Star as well as older constructions (models), chassis cabs
- **NEOPLAN** Cityliner, Starliner, Tourliner, Trendliner
- **TEMSA** Diamond, **WISEON** high-decker
- Diameter: 114 mm

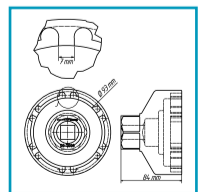

20 3/4"
s 46 mm

 Made in Germany

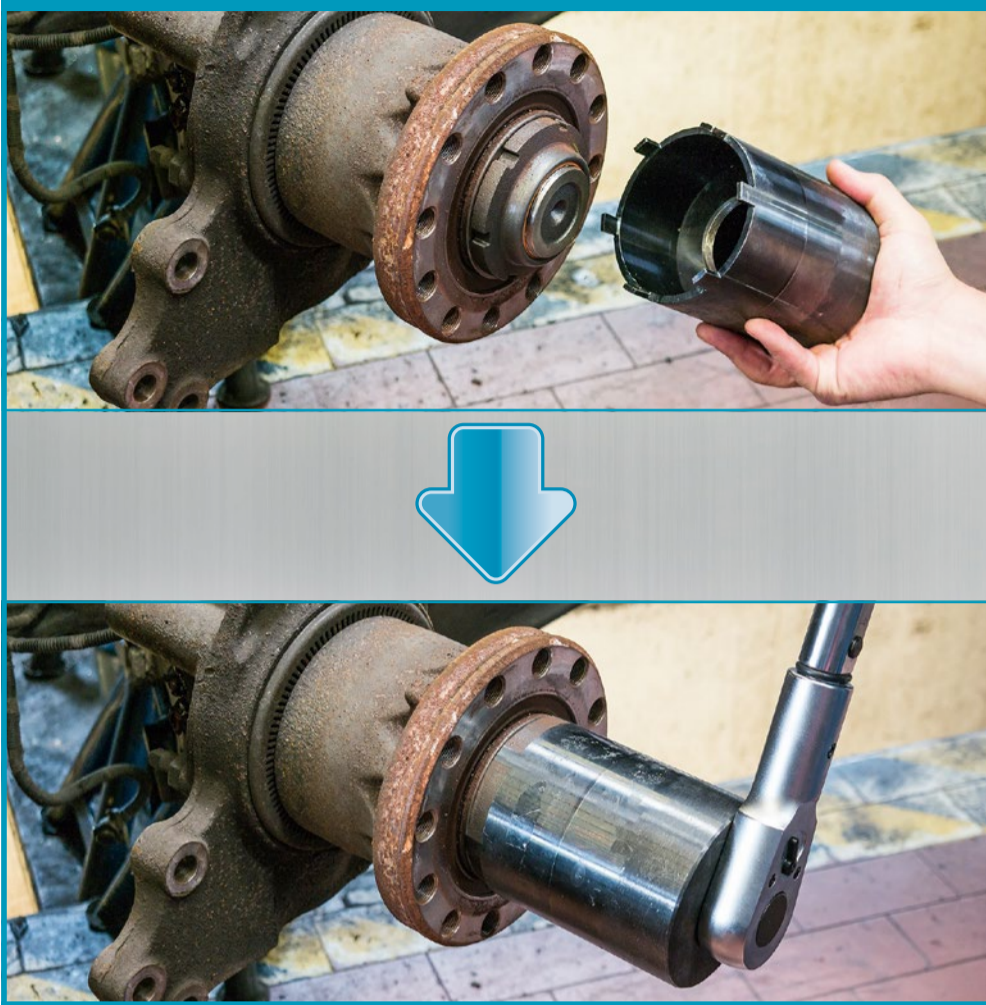

4937-87/3, EAN-No. 4000896199235

20 3/4 3

3/4" Commercial vehicle pin wrench set for MAN, MERCEDES-BENZ

- For repair and maintenance work on the wheel hub, wheel bearing or brake disc
- For e.g. **MAN** TGL front axle since 2000 and L 2000 **MERCEDES-BENZ** Atego rear axle HL2, 814 Vitaro
- Pin wrench for rear axle, inside \varnothing : 87 mm
- Length (total): 65 mm
- 6 pins, width of pins: 10 mm
- With 2 replaceable guide tubes
- Outside \varnothing : 49 mm, 57 mm
- Length including guide tube (total): 140 mm



Slotted nut

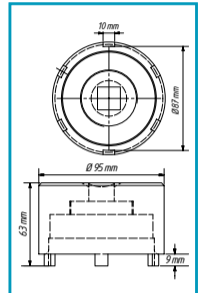

4937-101/4, EAN-No. 4000896199266

20 3/4 4

3/4" Commercial vehicle pin wrench set for rear axle MERCEDES-BENZ

- For dismantling / assembly work on the rear axle as well as repair and maintenance work on the wheel hub, wheel bearing or brake disc
- **MERCEDES-BENZ** hub-reduction axle, such as trailing axle NR7/4
- **MERCEDES-BENZ** hub-reduction rear axles (Euro-axles) 10 t and 13 t,
- **MERCEDES-BENZ** hub-reduction axle 7 t AL7/1
- Inside \varnothing : 101.5 mm
- Length including guide tube (total): 140 mm
- 12 pins, width of pins: 11.4 mm
- With 3 replaceable guide tubes
- Outside \varnothing : 50, 51, 53 mm
- Length (total): 85 mm

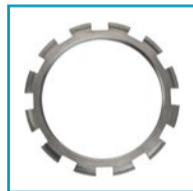

Slotted nut

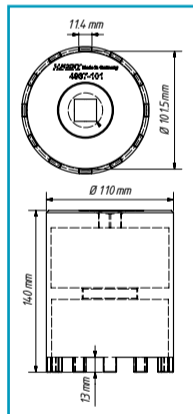

Made in Germany

4937-103/3, EAN-No. 4000896199259

20 3/4 3

3/4" Commercial vehicle pin wrench set for rear axle MAN and MERCEDES-BENZ

- For repair and maintenance work on the wheel hub, wheel bearing or brake disc
- For **MAN** and **MERCEDES-BENZ** 10 t and 13 t AP Hypoid and tag axle N7/4, Omnibus 0305G, 0405G
- **MAN** hub-reduction rear axle F series H7, HD7
- Hypoid rear axle F series HY-1175, HDY-1175
- Inside \varnothing : 103 mm
- Length including guide tube (total): 140 mm
- 6 pins, width of pins: 11.5 mm
- With 2 replaceable guide tubes
- Outside \varnothing : 51.5 mm, 66.5 mm
- Length (total): 135 mm



Slotted nut

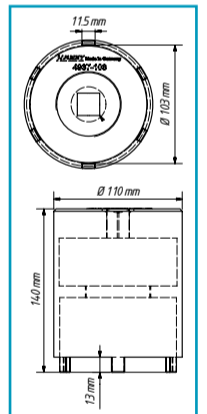

Made in Germany

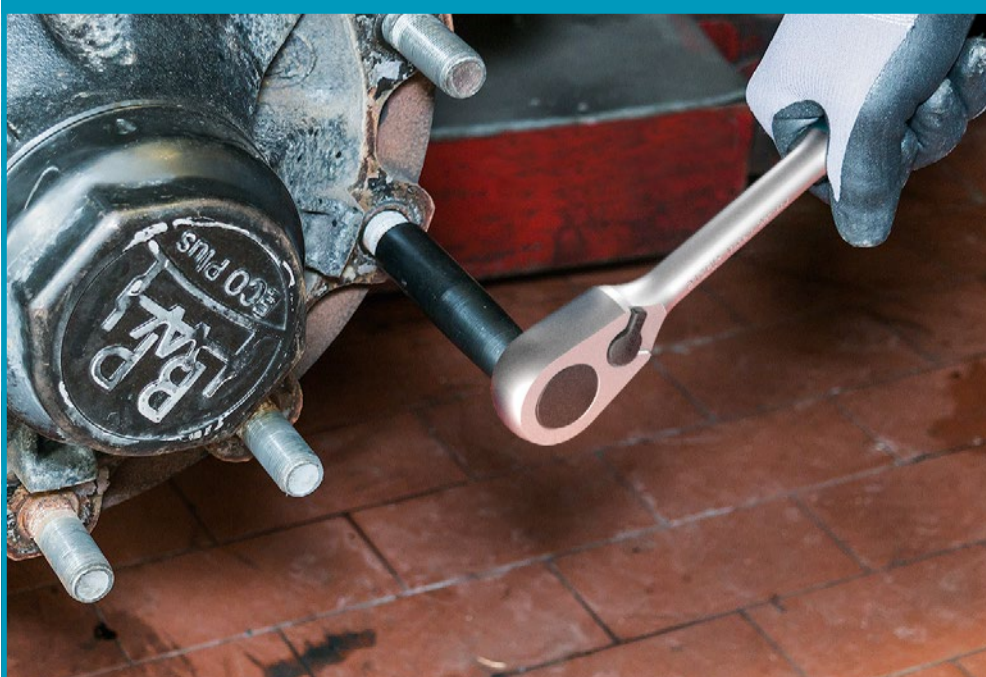

4937-26/3, 4937-27/3

125 1/2 3

1/2" Commercial vehicle centring sleeve set

- For fast assembly of centred truck drop centre rim wheels for rim hole \varnothing 26 mm
- No damage to the thread as well as exact centring of the rims thanks to conically cranked sleeves
- Length (total): 115 mm

Made in Germany

HAZET No.	For rim hole \varnothing 26 mm	EAN-No. 4000896 +
4937-26/3	M22 x 1.5 e.g.: DAF. FORD. MAN. MERCEDES-BENZ. RENAULT. Volvo	199013
4937-27/3	3/8"-11G e.g. SCANIA	202010



4937-7588,
EAN-No. 4000896202003

Commercial vehicle mounting sleeve SAF – thread M 75 x 1.5 right/left

- The bushing has both a left and a right thread, M 75x1.5
- For **SAF** axles with disc and drum brakes with \varnothing 88 mm bearing seat
- Only lift the 40 kg bearing unit (bearing + brake disc + wheel hub) onto the mounting sleeve once, then push up to the bearing seat
- Outside \varnothing : 88 mm
- Drive via lateral rod or without additional tools is possible (handle surface)



Made in Germany

4937-7582,
EAN-No. 4000896201969

MAN commercial vehicle mounting sleeve – thread M 75 x 1.5

- Mounting sleeve to protect the thread on the axle during bearing disassembly and assembly
- Use with **MAN** TGL, TGM, L series, HL 2
- Only lift the approx. 40 kg bearing unit (bearing + brake disc + wheel hub) onto the mounting sleeve once, then push up to the bearing seat with \varnothing 82 mm
- Thread: M 75 x 1.5
- Outside \varnothing : 82 mm
- Drive via lateral rod or without additional tools is possible (chequered handle surface)



Made in Germany

4937-7578,
EAN-No. 4000896201990

MERCEDES-BENZ commercial vehicle mounting sleeve – thread M 75 x 1.5

- Mounting sleeve to protect the thread on the axle during bearing disassembly and assembly
- Use in **MERCEDES-BENZ** Atego, Atego 2, Tourino
- Only lift the approx. 40 kg bearing unit (bearing + brake disc + wheel hub) onto the mounting sleeve once, then push up to the bearing seat with \varnothing 78 mm
- Thread: M 75 x 1.5
- Outside \varnothing : 78 mm
- Drive via lateral rod or without additional tools is possible (chequered handle surface)



Made in Germany



4937-100, EAN-No. 4000896201983

MAN commercial vehicle mounting sleeve – thread M 100 x 1.5

- Mounting sleeve to protect the thread on the axle during bearing disassembly and assembly
- Use with **MAN** TGX, TGA, TGS e.g. for **MAN** HY 1350 axle (13 t)
- Only lift the approx. 40 kg bearing unit (bearing + brake disc + wheel hub) onto the mounting sleeve once, then push up to the bearing seat with \varnothing 105 mm
- Thread: M 100 x 1.5
- Outside \varnothing : 105 mm
- Drive via lateral rod or without additional tools (chequered handle surface) is possible



Made in Germany



4937

Commercial vehicle hub cap socket, \varnothing 110 mm and 120 mm for flat oval BPW hub cap

- For **BPW** Eco and Eco Plus axles
- Perfect fit for **BPW** contour \varnothing 110 mm or \varnothing 120 mm



Made in Germany

HAZET No.	□	l / mm	EAN-No. 4000896 +
4937-110	25 1"	110	199273
4937-120	20 3/4"	141	210459

4937-105/2, EAN-No. 4000896201938

1" Commercial vehicle axle nut socket set DAF, RENAULT, Volvo

- 6-point output: \leq 105 mm
- Drive: 25 mm (1") and outside 6-point \leq 60 mm
- Screw-in guide tube allows for flexible application
- **DAF** with guide tube
- **RENAULT, Volvo** without guide tube
- With outside guide collar



25 1" 60

25 1" 60 2

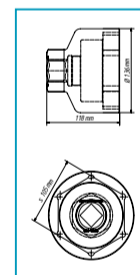

Made in Germany

3 applications – 1 wrench!



772-2/16, EAN-No. 4000896161041

3/4" Universal tool set for axle and slotted nut wrench set

- For removal and precise installation, e.g. with 6-point and 8-point nuts, slotted nuts, face nuts, round nuts with drilled holes, round nuts with pin holes, etc.
- Clamping range: 35–170 mm
- Torque (max.): 700 Nm
- 16-pieces in HAZET Safety-Insert-System soft foam insert

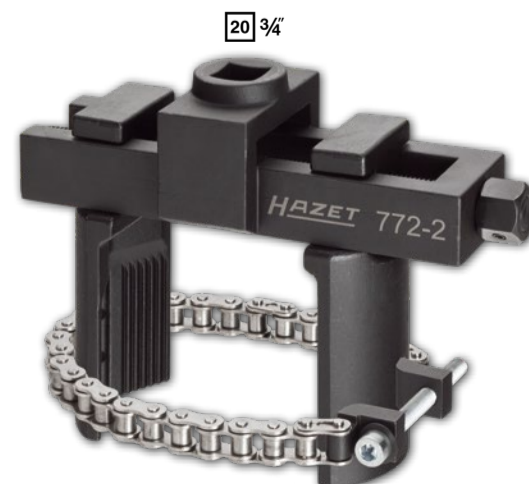

20 3/4"



20 3/4" 16



1779-3, EAN-No. 4000896135998

Universal ball joint puller

- Universal application e.g. for trucks, lightweight design
- Jaw opening a : 32 mm
- Clamping range sb : 85 mm

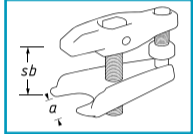

Made in Germany

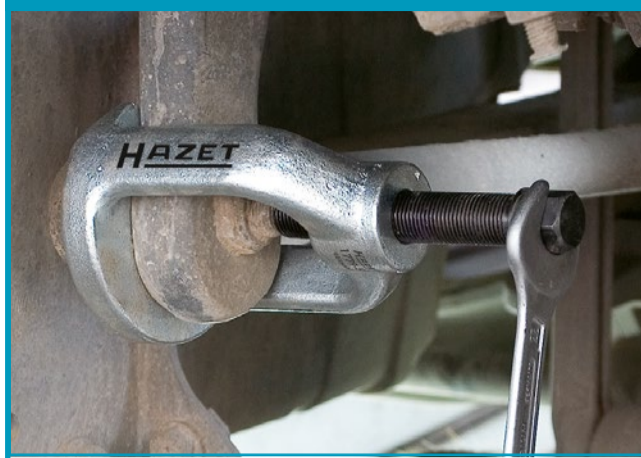

1779-55, EAN-No. 4000896136407

Ball joint puller

- For removing the ball joint pivots of steering tie rods, stabilisers, etc.
- Jaw opening: 55 mm
- Clamping depth: 80 mm
- Width: 77 mm

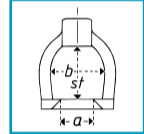

Made in Germany

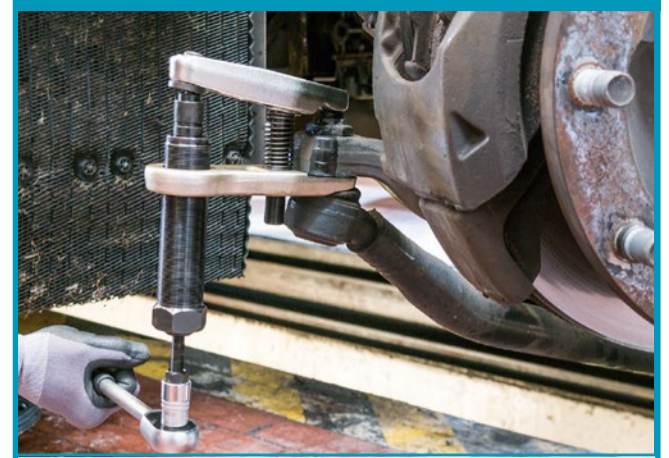

1790

Ball joint puller

- For the easy extraction of ball joint pivots and safe removal of ball joints
- **Supported by hydraulic system**
- Load (max.): 12 t

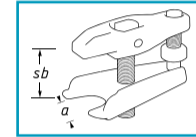

Made in Germany

HAZET No.	a mm	sb mm	EAN-No. 4000896 +
1790-5	30-34	70	145461
1790-6	36-40	85	145478

1004S, 1104S

Impact socket (6-point)

- DIN 3129, ISO 2725-1

1004S-32

- Especially long 6-point nut-driver design e.g. for deep wheel bolts/nuts on commercial vehicles
- For impact operation
- Surface: phosphatized



1004S-33

- Extra long design
- E.g. for deeply located wheel nuts and bolts on commercial vehicles
- With borehole for locking pin or safety spring and groove for o-ring



1104S-32

- For impact operation
- With bolt for locking pin retaining
- Surface: phosphatized

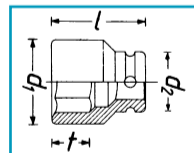

Made in Germany

HAZET No.	Drive	l mm	d ₁ mm	d ₂ mm	f mm	EAN-No. 4000896 +
1004S-32	20 3/4"	400	48.0	44.0	32.0	055784
1004S-33	20 3/4"	400	48.0	44.0	32.0	055791
1104S-32	25 1"	270	48.5	54.0	30.5	002665

1790-3, EAN-No. 4000896145454

Ball joint puller

- For extracting the ball joint pivots of steering arms, steering tie rods, stabilisers
- Jaw opening a : 40 mm
- Clamping range sb : 85 mm

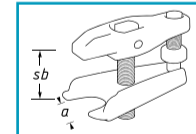

Made in Germany

4961N-23/12, EAN-No. 4000896186754

Wheel hub grinder

- For optimal cleaning of wheel hubs and brake discs
- Hook and loop fastener for quick changing of grinding wheels
- With hexagon insert for firm hold at the device
- **8-point profile** for safe and firm fixation
- Inside \varnothing (max.): 23 mm
- Grinding wheels \varnothing : 56 mm

**For stud bolts!
No wheel hub
chippings!**



Made in Germany

720S, EAN-No. 4000896029532

Four-way rim wrench

- Forged central piece
- Length (total): 750 mm



Made in Germany



2784SR-1, EAN-No. 4000896229758

12 1/2

1/2" Striking face wrench (special profile)

- Special application in case of lack of space due to design and very low vehicle body
- Optimised special profile for damage-free attachment of the flat-head lightweight nuts
- For the operation of the lightweight nuts on the frame, fifth-wheel coupling, front carrier and vibration damper with special profile **MERCEDES-BENZ** on the Actros, Antos, Arocs, model year 2016 →
- Surface: phosphatized



Made in Germany

2169-9, EAN-No. 4000896116690

12 1/2 24

1/2" Commercial vehicle oil filter wrench

- For the operation of oil filters e.g. from **MANN** and **MAHLE/KNECHT**
- For e.g.: **Volvo, SCANIA, RENAULT, MAN, IVECO, FIAT, FODEN, IRISBUS, ASTRA, CATERPILLAR, LIEBHERR, JOHN DEERE, KOMATSU, FAUN, MITSUBISHI**
- The torque value recommended by the vehicle manufacturer can be safely achieved, e.g. with a HAZET torque wrench (Attention: observe the manufacturer's tightening torque value)



For over
1600
applications!

Made in Germany



2784S

1/2" Impact socket (special profile) MERCEDES-BENZ

- Optimised special profile for damage-free attachment of the flat-head lightweight nuts
- For the operation of the lightweight nuts on the frame, fifth-wheel coupling, front carrier and vibration damper with special profile **MERCEDES-BENZ** on the Actros, Antos, Arocs, model year 2016 →
- Surface: phosphatized
- Output: special profile



12 1/2

Made in Germany

HAZET No.	Type	l mm	EAN-No. 4000896 +
2784S-1	short	46	213252
2784SLg-1	long	75	218240



2169-36, EAN-No. 4000896086566

10 3/8

3/8" Oil filter wrench

- For **MERCEDES-BENZ** Transporter, Actros MP 1, MP 2
- For **MAN** fuel filters, e.g. TGA
- Forged design
- Surface: chrome-plated



Made in Germany



652, 653

Tyre lever

- Heavy design

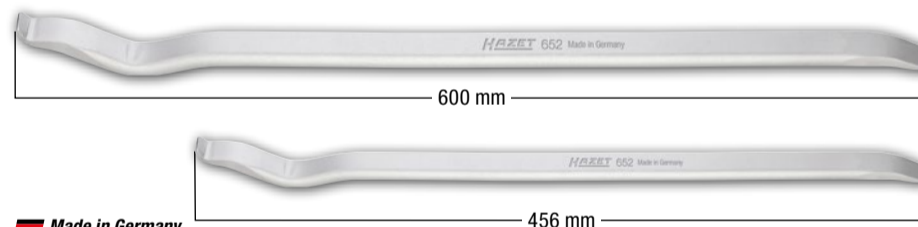

Made in Germany

HAZET No.	l mm	g	EAN-No. 4000896 +
652	600	1130	028702
653	456	630	028719



2169-32, EAN-No. 4000896082346

3/8" AdBlue® filter wrench MAN

- For installing and removing oil filters and oil filter housing caps when changing the oil filter element
- Forged design
- For urea solution filter Ad-Blue® MAN e.g. TGX



Made in Germany

Safe loosening and tightening of oil filter and AdBlue® covers!



2168-46, EAN-No. 4000896156252

3/8" AdBlue® filter wrench MERCEDES-BENZ

- For operation of the filter housing cap when replacing the filter element for **AdBlue® filters (urea solution filter element)** on **MERCEDES-BENZ** commercial vehicles with BlueTec® engines e.g. Actros, Atego, Axor, Eonic
- The tightening torque recommended by the vehicle manufacturer (please follow the instructions of the manufacturer) is reached e.g. with the torque wrench HAZET 5110-3CT
- Forged design



Made in Germany



4685-3, EAN-No. 4000896230730

12.5 1/2

1/2" CLAAS operating tool

- For manual operation of attachments for CLAAS JAGUAR, e.g. ORBIS, PICK UP, DIRECT DISC and CORIO CONSPED
- 3 magnets ensure secure hold on the quick coupler
- Precise positioning of the tool on the quick coupler
- Saves on second worker by turning alone using 12.5 mm (1/2") ratchet (e.g. HAZET 916HP)
- Simple turning of the attachment possible
- Safe tool actuation outside the danger zone
- Light aluminium tool
- Specially adapted to requirements in field use
- Diameter: 118 mm
- Length (total): 65.5 mm



12.5 1/2

Facilitates work on, for example, the CLAAS maize header!



Made in Germany



Tool with suitable profile for quick coupler



Attaching the tool



Secure hold thanks to integrated magnets

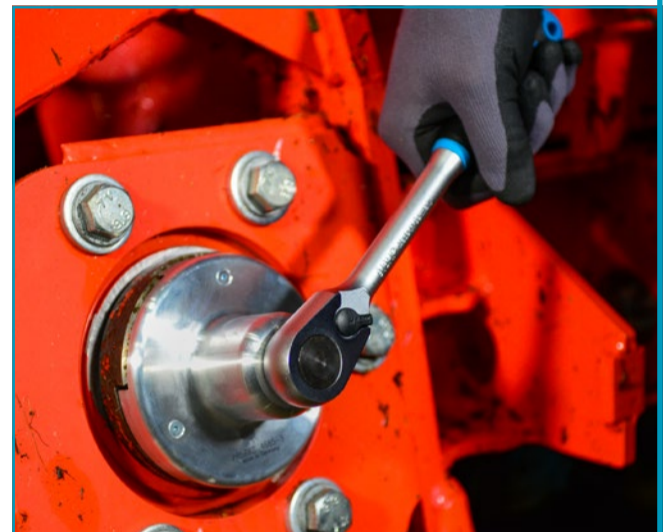

Operating using ratchet with inserted 12.5 mm (1/2") 4-point socket

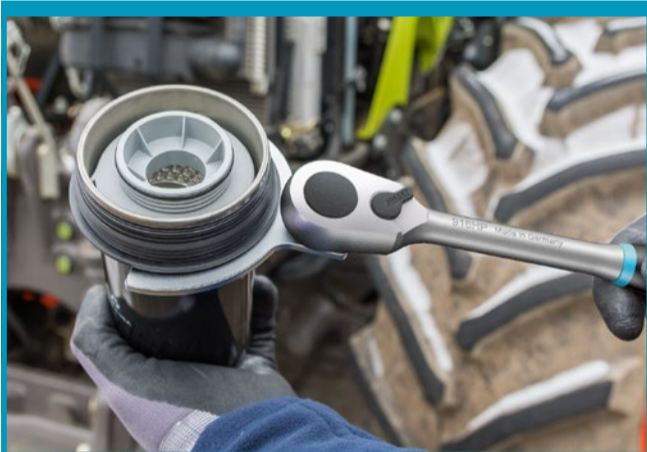

2168-1, EAN-No. 4000896223251

12.5 1/2

1/2" Fuel filter wrench

- For use of fuel filter housing in construction machinery and agricultural machinery
- Easy operation with integrated square, 12.5 mm (1/2")
- For e.g.: CLAAS Torion, LIEBHERR wheel loaders and wheel loaders with Euro 6 emission standard and LIEBHERR engines, JOHN DEERE tractors series 6M, 6R · tractor series 7R · combine harvester series T · combine harvester series W · self-driving field sprayers R403, R4040L, R4050L · bulldozer 700K · Deere excavator 210G LC · harvesters 1070G, 1170G · forwarders 1110G, 1210G, 1510G · crawler forest cranes 2154G, 2154G · log loaders 2156G, 2156G LC · trailers-mounted forest cranes 337E, 437E · wheel loaders 524K, 524K-II, 524L, 544K, 544L · Hagie sprayers STS 10, STS 12 · Mazzotti MAF



12.5 1/2

Easy loosening and unscrewing, even in narrow work spaces!

Made in Germany



4685

Taper key extractor

- Safe removal of taper keys from gear wheels on agricultural machinery

4685-1, EAN-No. 4000896222889

Taper key extractor · straight

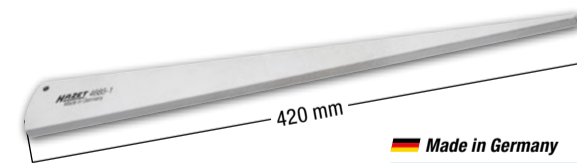

420 mm

Made in Germany

4685-2, EAN-No. 4000896222896

Taper key extractor · bent

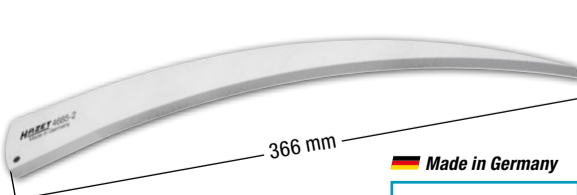

366 mm

Made in Germany



4685-4, EAN-No. 4000896231126

12.5 1/2

1/2" Tubular socket wrench

- For dismounting/mounting the multi-fingers on CLAAS, LEXION, TUCANO and AVERO combine harvesters
- Multi-finger operation possible through the very narrow opening on the feed drum
- Easy to drive with introduced square by means of a 12.5 mm (1/2") ratchet (e.g. HAZET 916HP)
- Application of torques on multi-fingers possible
- With 6-point output: s 24 mm

Disassembly / assembly with just one tool!

12.5 1/2



s 24 mm

Made in Germany

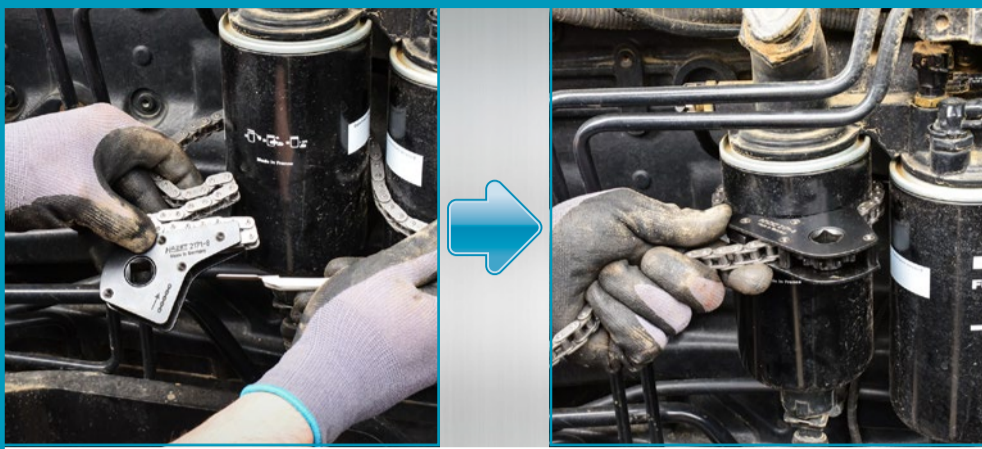

2171-8Lg, EAN-No. 4000896203703 125 1/2

1/2" Commercial vehicle oil filter chain wrench, open

- Clamping range 50–150 mm
- For removing oil filters and the operation of air dryer cartridges
- Especially suited to limited space
- The opening in the oil filter chain wrench facilitates application even in places which, due to the construction, cannot be reached from above with an operating tool

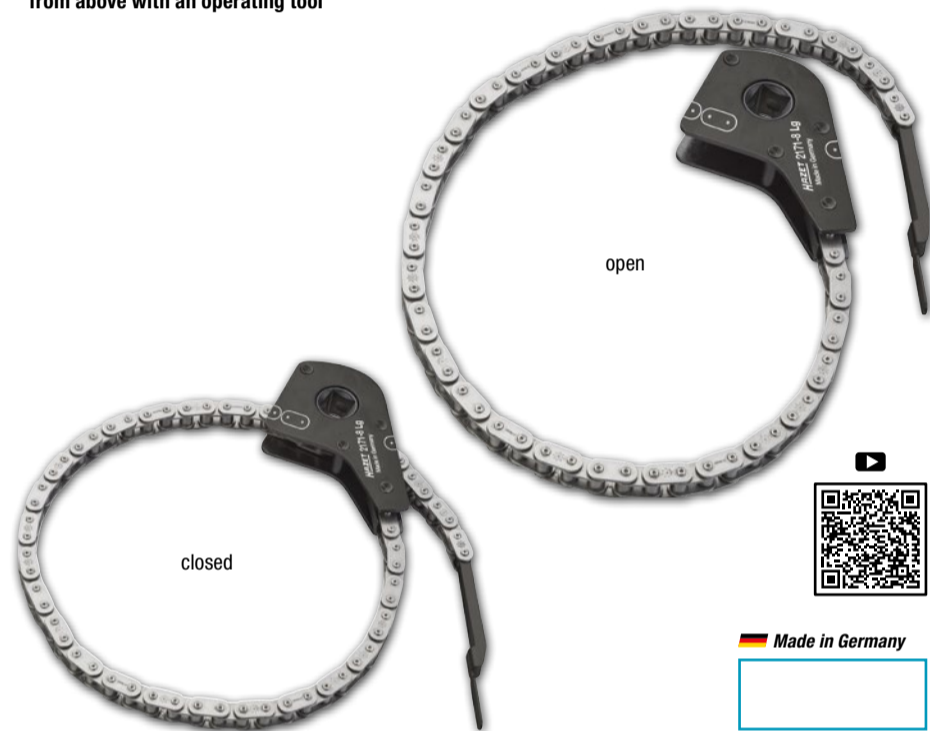

4800/6, EAN-No. 4000896216482 6

Radiator tester for agricultural machinery

- Checking for leakage in cooling systems and heating circuits
- 4800-1 Cooling pump to 2.5 bar
- 4800-2 Intermediary piece, flexible hose
- 4800-3 Radiator adapter for **AMAZONE** Pantera, **CLAAS** Jaguar · Lexion · Scorpion · Ares · Atlas · Ceres, **FENDT**, **MASSEY FERGUSON** with tank no. 180224M92 and 4296015M1, **CASE** Quadtrac · Magnum
- 4800-4A Radiator adapter for **CASE** Puma · SBS · LBS · Optum · Maxxum · CVX, **NEW HOLLAND** TVT · T7, T7 Elite Pack · T6, **FENDT** Vario model year 2000 → Combine harvester L series, **CLAAS** Arion · Axion, **DEUTZ** engines 3.6 PowerPack · BF6M1013FC · TCD2013L6 2V and 4V genset 250 kW
- 4800-5A Radiator adapter for **FENDT** Farmer 300 model year 1988 → Type 500 · Type 700 · Vario model year 1988 → 2000
- 4800-20 Radiator adapter for **CLAAS** Xerion · Tucano as well as all new **CLAAS** machines with **MERCEDES-BENZ** expansion tank
- Classification for vehicles types: www.hazet.de → The Tool Finder → Radiator adapters 4800

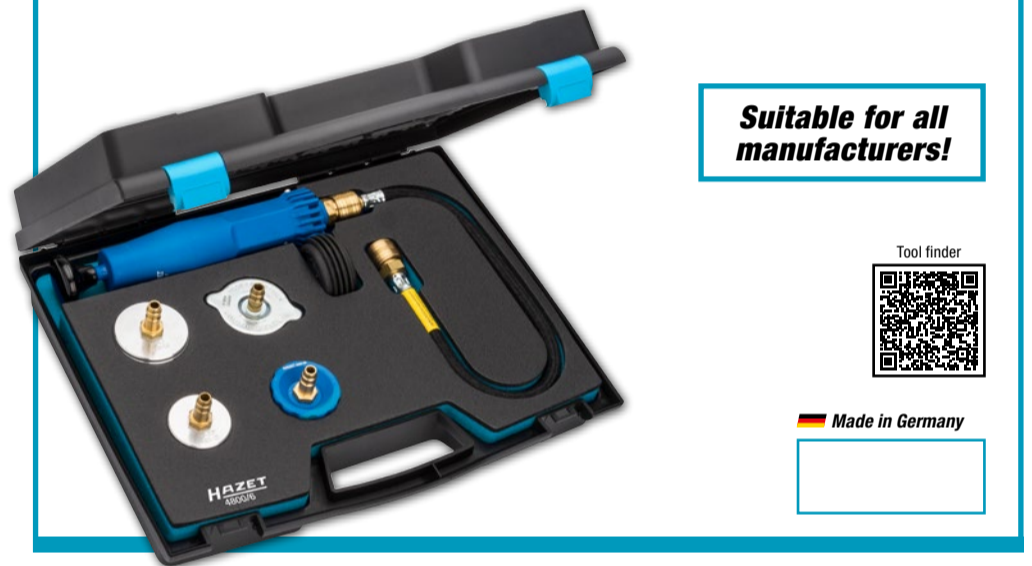

Suitable for all manufacturers!



197-4, EAN-No. 4000896214235

Axle oil collecting pan for commercial vehicles, 3 l

- Safe collection of the oil dripping from the axle when removing or repairing the full-floating axles on trucks and agricultural machinery
- Chemical-resistant, unbreakable plastic with smooth, abrasion-proof surface
- Dimensions (L x W x H): 310 x 240 x 160 mm



2150-1, EAN-No. 4000896144129

Marking tool

- For marking metal and other materials with smooth surfaces
- Special steel for long-lasting use
- With fastening clip
- Length (total): 150 mm



839-1, EAN-No. 4000896035670

Voltmeter

- 220–250 V according to standard DIN VDE 06800-6
- Slotted blade, concave ground
- Extra long handle: 92 mm
- With clip
- Defective glow tube not replaceable according to VDE
- Length (total): 150 mm
- Slot profile: 0.5 x 2.8 mm



Made in Germany



9040Lg-3/2, EAN-No. 4000896206339



Air blow gun

- With 90° lateral nozzle **1** and Venturi nozzle **2**
- For cleaning areas with restricted access on vehicles, machinery and agricultural machinery
- Especially suitable for cleaning cooling fins
- Grip area with insulated lance to protect it from cold
- Increased efficiency due to Venturi nozzle (54 mm)
- 90° lateral nozzle (32 mm) enables cleaning of cooling fins
- Pressure (max.): 12 bar
- Ergonomic handle
- Coupler plug (incl.): 7.2 nominal size
- Hose diameter (recommended): 10 mm
- Working pressure: 6.3 bar
- **Length (total): 1,085 mm**
- Air requirement: 450 l/min (7.5 l/sec)
- Weight (net): 0.31 kg

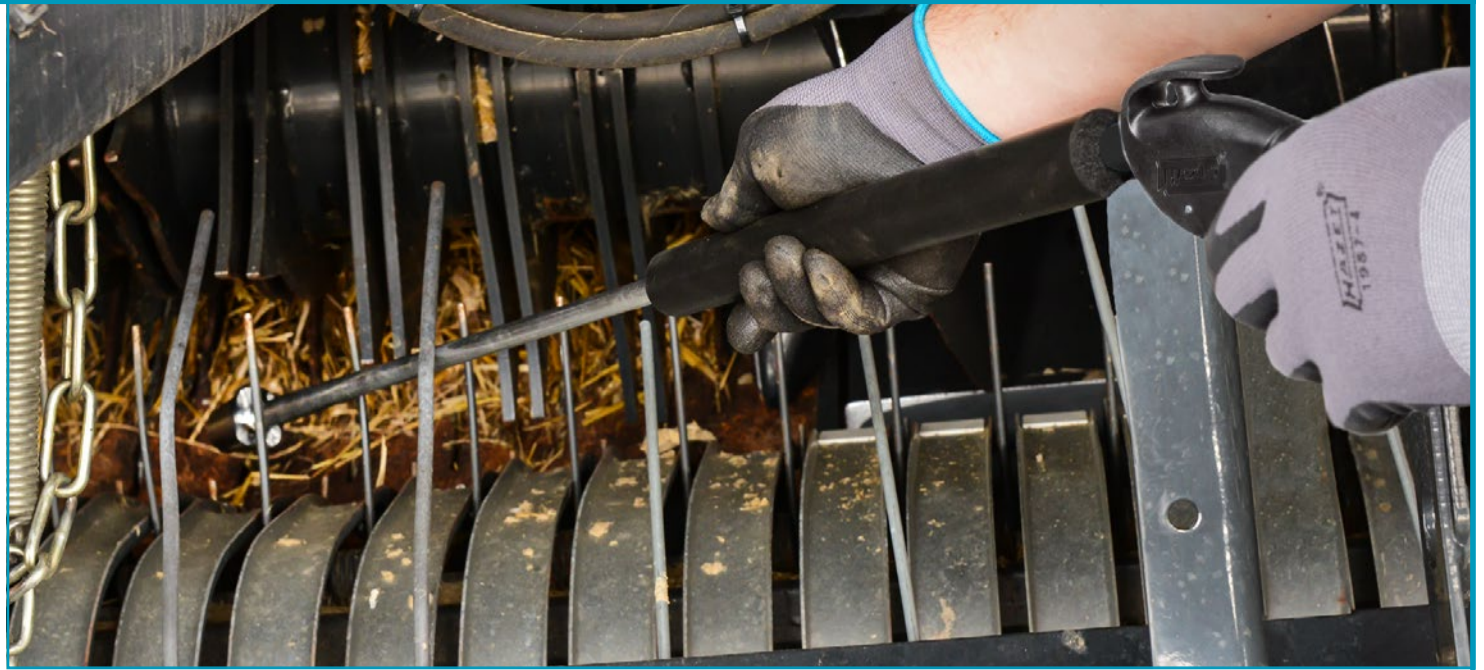

1 L = 32 mm

2 L = 54 mm

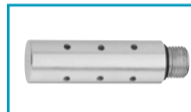

1,085 mm – extra long!

9040Lg-3-01, EAN-No. 4000896241514

Venturi nozzle

- **100% increase in air outlet quantity thanks to Venturi effect**
- For blowing out machines, cargo spaces and buildings in industry, agriculture and trade
- Optional Venturi nozzle for 9040-4 and 9040Lg-3/2



9040Lg-3-02, EAN-No. 4000896241521

Lateral nozzle 90°

- **Nozzle allows lateral blowing out**
- Cleaning cooling fins and other hard-to-reach areas
- Optional lateral nozzle for 9040-4 and 9040Lg-3/2

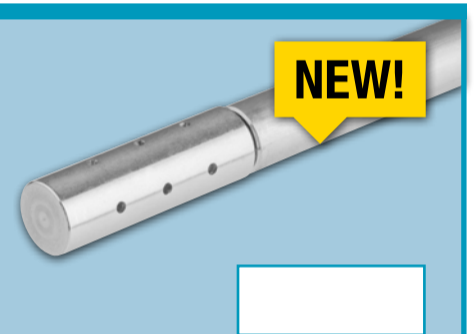

9040P-1, EAN-No. 4000896209545

Air blow gun 100 mm

- For fast removal of shavings or other foreign objects, especially in areas that are difficult to access
- Standard nozzle with bent pipe (∅ 8 mm)



9040-7, EAN-No. 4000896153404

Spiral hose 7.62 m

- Polyurethane
- Inside ∅: 6.35 mm
- Connecting pieces with 360° rotary joints
- Burst pressure according to DIN: 55.1 bar / 800 PSI
- Working pressure: 10 bar

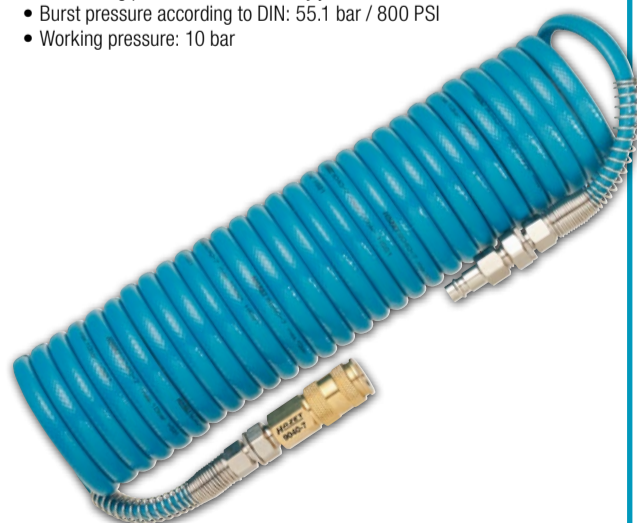

197-3, EAN-No. 4000896158584

Magnetic cup

- **Holds small parts such as screws etc.**
- Magnetic foot allows fixation to tool trolleys, workshop panels, car lifts etc.
- Diameter: 150 mm





“
High quality and impressive performance yet with a compact design, those are the biggest selling points for our new impact wrenches!
 ”

Fabian · Sales Representative
 Worked in a workshop for tyre services during his time at university. There he discovered his passion for our pneumatic machinery.

Twin Effect – More power in less time!

- Maximum efficiency due to the ground-breaking "HAZET Twin Turbo technology", enables high torques with compact design
- Innovative 8-blade air motor with 25% higher impact performance ensures maximum torque
- Long service life and high efficiency in industrial and automotive applications

- Significantly higher performance results in faster loosening of the screw connection during the screwing procedure and is thereby twice as efficient.

Advantage:
 saves time as the work procedure is completed faster, thereby consuming less air = cost savings!

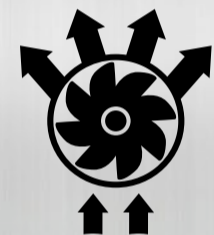

Twin Turbo
 Technology by HAZET



9012ATT, EAN-No. 4000896234738

1/2" Rotating impact wrench

- Loosening torque (max.): 550 Nm*
- Operation of brake calliper screw connections and other screw-joints that are difficult to reach in the area of steering, shock absorbers, gearboxes
- Handle / trigger adjustable around its own axis for optimal handling allows operation in any position
- Innovative swivel mechanism for extended application range guarantees best accessibility
- Reduced vibrations
- One-hand operation for left- and right-handed users
- Rotation speed: 8,000 rpm
- Weight (net): 1.3 kg
- Air requirement: 113 l/min (1.9 l/sec)
- Coupler plug (incl.): 7.2 nominal size

Short, compact, angled design – only 70 mm!



Swivel head 120°



Rotating handle 360°



NEW!

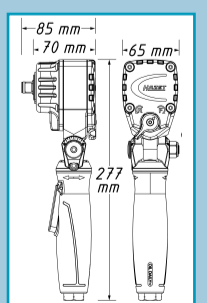

*Determined using screw size M32

Twin Turbo (TT) impact wrench

- Exhaust air is guided downwards through the handle
- Forward/reverse: two-stage (forward), single-stage (reverse)
- Reduced vibrations



9012TT, EAN-No. 4000896226924 12⁵ 1/2"

1/2" Impact wrench

- Loosening torque (max.): 2,200 Nm
- Rotation speed: 8,300 rpm
- Weight (net): 1.6 kg
- Air requirement: 147.2 l/min
- Coupler plug (incl.): 7.2 nominal size



Extra short – only 128 mm!

9013TT, EAN-No. 4000896227143 20 3/4"

3/4" Impact wrench

- Loosening torque (max.): 4,100 Nm
- Rotation speed: 5,200 rpm
- Weight (net): 4.5 kg
- Air requirement: 243.5 l/min (4.1l/sec)
- Removable handle, 360° adjustable
- Coupler plug (incl.): 7.2 nominal size



Extra short – only 184 mm!

9014TT, EAN-No. 4000896234684 25 1"

1" Impact wrench

- Loosening torque (max.): 4,100 Nm
- Rotation speed: 5,200 rpm
- Weight (net): 4.6 kg
- Air requirement: 235 l/min (3.9 l/sec)
- Removable handle, 360° adjustable
- Coupler plug (incl.): 10 nominal size



Super strong and easy to handle!



Twin Turbo (LGTT) impact wrench with long spindle

- Long spindle for reaching deep screw connections
- Exhaust air is guided downwards through the handle
- Long service life and high efficiency in industrial and automotive applications
- Reduced vibrations
- One-hand operation for left- and right-handed users
- Removable handle, 360° adjustable

9013LGTT EAN-No. 4000896232277 20 3/4"

3/4" Impact wrench · 186 mm

- Loosening torque (max.): 3,800 Nm*
- Spindel length: 186 mm
- Rotation speed: 5,200 rpm
- Weight (net): 5.5 kg
- Air requirement: 243 l/min (4 l/sec)
- Coupler plug (incl.): 7.2 nominal size



* Determined using screw size M32

9014LGTT EAN-No. 4000896234677 25 1"

1" Impact wrench · 240 mm

- Loosening torque (max.): 3,850 Nm*
- Spindel length: 240 mm
- Rotation speed: 4,600 rpm
- Weight (net): 5.9 kg
- Air requirement: 235 l/min (3.9 l/sec)
- Coupler plug (incl.): 10 nominal size

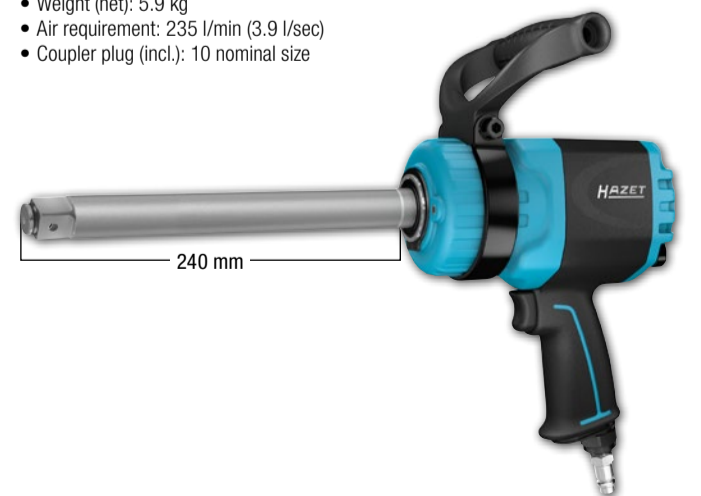

* Determined using screw size M32

9041-1, EAN-No. 4000896147076

Tyre inflator

- Handle with operating lever and discharge knob (for one-hand use)
- Hose with plug-in nipple
- Manometer measuring range: 0–12 bar (graduation: 0.1 bar)
- Flexible tube, length: 400 mm
- Air inlet: inside thread 12.91 mm (1/4")
- Coupler plug (incl.): 7.2 nominal size



9042P-4, EAN-No. 4000896209613

Car body gun for underbody protection and cavity sealing

- Suitable for aqueous and oily liquids
- Application field: -10°C to +80°C
- Working pressure (max.): 16 bar
- Air requirement with cavity tube: 180 l/min at 8 bar
- Nozzles made of steel/plastic
- Coupler plug (incl.): 7.2 nominal size



Including metal intake pipe, nozzle and cavity tube!



9042N-1, EAN-No. 4000896176472

Grease gun, pneumatic

- 360° adjustable handle
- Continuous pumping of grease
- Gun-filling with grease cartridges, loose grease or via dispenser
- Filling capacity (approx.): 400 ml
- Air requirement: 230 l/min
- Nylon tube: 230 mm
- Metal tube: 172 mm
- Weight (net): 2.0 kg
- Coupler plug (incl.): 7.2 nominal size



9040-4, EAN-No. 4000896176236

2-way air blow gun

- Choice of air supply at tool head or handle
- Pressure regulator
- Exchangeable nozzles (steel)
- Short nozzle for areas with restricted access
- Aluminium housing
- Coupler plug (incl.): 7.2 nominal size

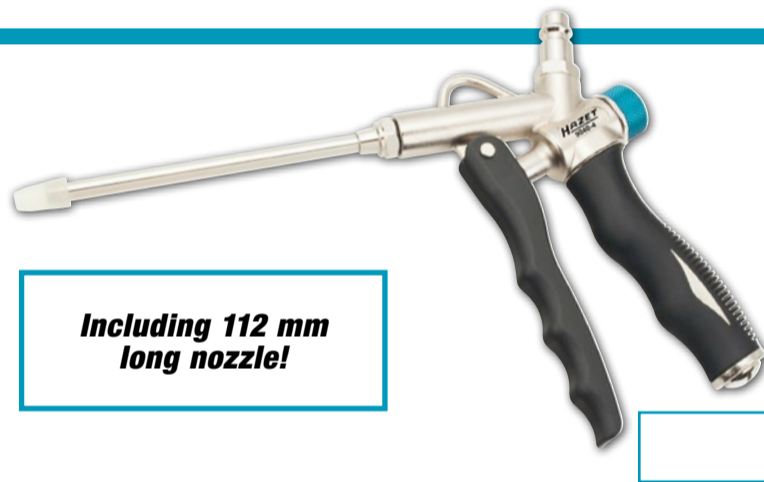

Including 112 mm long nozzle!

9033P-8, EAN-No. 4000896190515

Angle grinder

- Suitable for cutting metal sheet and steel
- Quick adjustment (without tools) of protective cover
- Pressure key for locking the output enables easy changing of cut-off wheels
- Low build height
- Coupler plug (incl.): 7.2 nominal size
- Working pressure: 6.3 bar
- Cold insulated handle
- Length (total): 371 mm
- Weight (net): 1.7 kg
- Incl. 1 cut-off wheel (100 x 0.8 x 9.53 mm)



9033P-08/25, EAN-No. 4000896201402

Cut-off wheel set, 25 pieces

- Suitable for angle grinder 9033P-8
- Dimensions (L x W x H): 100 x 0.8 x 9.53 mm



9033N-4, EAN-No. 4000896210183

Belt sander

- Continuous speed regulation via speed regulator on back of handle
- For narrow surfaces (belt width 10 mm)
- Including three abrasive belts 330 x 10 mm (grain size 80, 100, 120)
- Locking device for quick belt changing
- Automatic belt adjustment
- 360° rotatable belt run
- Including hex-head wrench for fine adjustment of the belt and angle setting in the handle
- Coupler plug (incl.): 7.2 nominal size
- Cold insulated handle
- Length (total): 291.4 mm
- Weight (net): 0.81 kg



Speed regulation!
Power: 420 watts

9033

Abrasive belt set

- Abrasive belts 330 x 10 mm
- 10 pieces per package

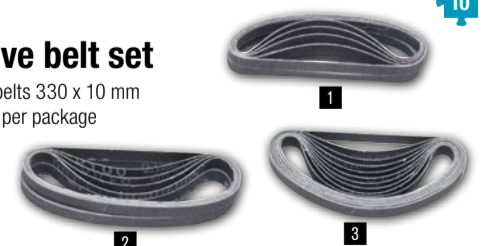

HAZET No.	No.	Grain size	EAN-No. 4000896 +
9033-480/10	1	80	139101
9033-4100/10	2	100	139118
9033-4120/10	3	120	139125

Want even more power?

→ Then loosen your 1/2" screwed connection now with our 3/4" power innovation. How it works: Take, for example, our 3/4" impact wrench 9013M and connect our adapter 1003S-1 to the square.

At the other end, connect our new sockets s 17 or s 19 mm with new hexagon socket and away you go!

→ Development and production:
 Made in Germany!

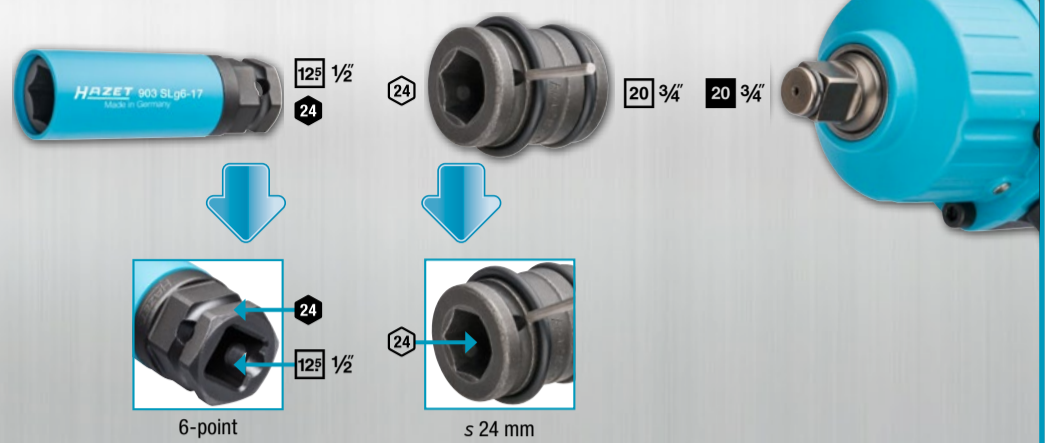

903SLg6

Impact socket (6-point)

- Operation via impact adapter e.g. HAZET 1003S-1 or nut-driver s 24 mm enables high force transmission
- Especially stiff wheel bolts can be loosened more easily via an optional 20 mm (3/4") impact wrench
- Especially suitable for vans and light trucks, e.g. FIAT Ducato, MERCEDES-BENZ Sprinter
- External hexagon on the socket wrench insert enables adaptation to 20 mm (3/4") drive
- Plastic casing protects rims against scratches

903SLg6



 Made in Germany

HAZET No.	S mm	EAN-No. 4000896 +
903SLg6-17	17	223596
903SLg6-19	19	223589

903SLg6/5,

EAN-No. 4000896223602

Set



 Made in Germany

985S

1/2" Impact socket

- Short design
- With borehole for locking pin or safety spring and groove for o-ring
- Surface: phosphatized, oiled
- DIN 3124, ISO 2725-2



 Made in Germany

HAZET No.	S mm	EAN-No. 4000896 +
985S-22	22	218219
985S-24	24	218226

900SLg6-24,

EAN-No. 4000896232789

1/2" Impact adapter with integrated hexagon

- Surface: phosphatized, oiled
- For operating wheel nuts on small trucks or vans, e.g. FIAT Ducato, PEUGEOT Jumper



 Made in Germany

1007S-7/4, 1003S-07

Impact adapter

- The enormous force of the 20 mm (3/4") drive results in high load on and increased wear of the 12.5 mm (1/2") output. The hexagon adaptation means the 12.5 mm (1/2") output is replaceable, making the adapter more versatile!
- With replaceable 12.5 mm (1/2") plug-in blades
- For impact operation
- With borehole for locking pin or safety spring and groove for o-ring



Problem solver

 Made in Germany

HAZET No.	Designation	EAN-No. 4000896 +
1007S-7/4	Impact adapter	215416
1003S-07	Replaceable plug-in blade $\frac{1}{2}$ "	215409

985S/11, 990S/11

Impact socket set

- 20 mm (3/4") drive allows transmission of high separation forces
- For screw connections e.g. on chassis, brake system (brake carriers), engines and shock absorbers
- Drive optionally with 12.5 mm (1/2"), 24 mm or with HAZET 1003-1 adapter
- With borehole for locking pin or safety spring and groove for o-ring



20 3/4" drive allows transmission of high separation forces!

 Made in Germany

HAZET No.	Output	Sizes	EAN-No. 4000896 +
985S/11	○	14, 17 and 19 in short and long version	211951
990S/11	○	14, 16 and 18 in short and long version	162406

900SZ6/11, EAN-No. 4000896225378

1/2" Impact socket set

- Half-inch socket with optional 3/4" drive thanks to adapter included in the set
- s 19 · 21 · 22 · 24 · 27 · 30 · 32 · 36 mm



Including soft foam insert!

 Made in Germany



“
"Easy does it" is a thing of the past. I always feel secure when tightening a screw fitting thanks to the HAZET torque wrench!
 ”

*Leo - Member of the Production Team
 Had his first experiences with HAZET tools in his father's workshop as a child.*

5145-3CT, EAN-No. 4000896218929 20 3/4"
3/4" Torque wrench 300–800 Nm

- No more turning back!
- Accuracy ±3% of the scale value (in direction of actuation for right-hand tightening)
- With serial number and certificate
- Length (total): 1.271 mm
- Graduation: 2.5 Nm



Bestseller!

Made in Germany



5000-3CT 6.3 1/4" 12.5 1/2"
Torque wrench 2.5–400 Nm

- No more turning back!
- Accuracy ±3% of the scale value (in direction of actuation for right-hand tightening)
- With serial number and certificate



Made in Germany

HAZET No.	□	Torque range Nm	l mm	Graduation Nm	EAN-No. 4000896+
5108-3CT	20 3/4"	2.5– 25	234	0.25	218882
5120-3CT	12.5 1/2"	10 – 60	320	0.50	218905
5122-3CT	12.5 1/2"	40 – 200	519	1.00	219001
5123-3CT	12.5 1/2"	60 – 320	628	2.00	218998
5143-3CT	6.3 1/4"	100 – 400	790	2.50	235407



6000-1CT 20 3/4" 25 1"
Torque wrench 400–1600 Nm

- No more turning back!
- Accuracy ±3% of the scale value (in direction of actuation for right-hand tightening)
- With serial number and certificate
- Incl. bag for safe storage



Made in Germany

HAZET No.	□	Torque range Nm	l mm	Graduation Nm	□	EAN-No. 4000896+
6150-1CT	20 3/4"	400–1000	1788	5	24.2–61.0	141067
6160-1CT	25 1"	600–1600	2455	5	26.1–70.1	155316

Especially for axles!



1862N, EAN-No. 4000896242627

Wire stripper · automatic

- Automatic scanning system, no adjustment to the cable cross-section necessary
- Application: Stripping of flexible cables (stranded wire) and solid conductors \varnothing 0.2–6.0 mm² or AWG 24 – 10
- Optimally positioned diagonal cutter up to 2.5 mm²
- Adjustable length stop: 6 – 15 mm
- Fastening element at end of handle
- Replaceable blades
- Not for work on or near electrically live parts



165 mm

Made in Germany

4672-11, EAN-No. 4000896135561

System cable release tool

- Installed on **MERCEDES-BENZ** Actros, Antos, Arocs
- For damage-free release of flat plug contacts
- Malfunctions due to loose contacts can be remedied easily, quickly and professionally
- With sliding caps protecting the blades from damage and avoiding the risk of injury
- MCP 1.5 mm/contact width 1.5 mm
- OEM quality – "Made in Germany"

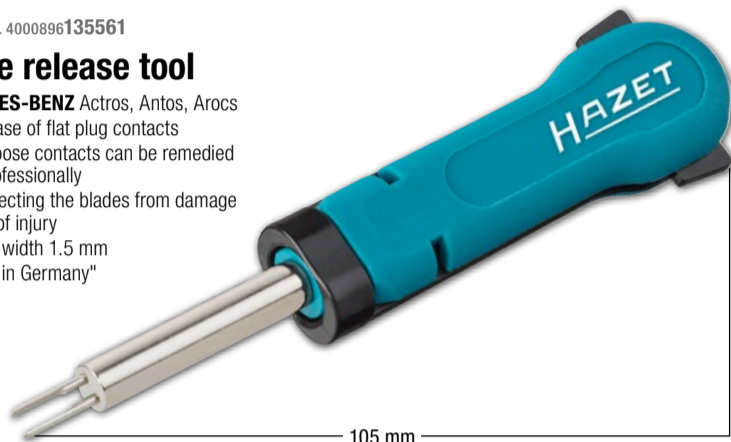

105 mm

For unlocking HDSCS connectors!

Made in Germany

4650-1, EAN-No. 4000896022014

Acid tester

- For checking the acid content of the battery fluid
- With aerometer
- Solid plastic housing - significantly reduced risk of breakage compared to glass enclosures



280 mm



Made in Germany

4670-9/5, EAN-No. 4000896205042

Commercial vehicle system cable release tool assortment

- Guarantees damage-free release of the most common commercial vehicle contacts
- Malfunctions due to loose contacts can be remedied easily, quickly and professionally
- With sliding caps protecting the blades from damage and avoiding the risk of injury
- OEM quality – "Made in Germany"



For damage-free release of flat plug contacts!

Made in Germany

4650-3, EAN-No. 4000896102051

Special tool for battery plugs

- Special length allows universal application in areas with restricted access
- For screwing battery plugs in and out
- Profile is especially suitable for battery plugs
- Plastic T-handle
- Surface: chrome-plated
- Screwdriver width: 14.5 mm
- Screwdriver height: 1.7 mm



95 mm

Made in Germany

4650-4, EAN-No. 4000896022038

Battery pole and terminal brush

- Cleaning the terminal posts and clamps
- With protective cover
- Also well suited for lawn mowers, snow blowers, etc.



120 mm



Made in Germany



2152N/3, EAN-No. 4000896204151

Electronic set

- For troubleshooting on electronic components
- Measuring range 3 – 48 V
- Voltage display LED: 5, 12, 24, 48 V
- Polarity display: LED for positive or negative, AC voltage with illuminated LED
- Additional crocodile clip and probe tip for attaching
- Cable length: 1,300 mm
- Probe tip, needle with sliding mechanism



3



“
We have the world's only readjustable, high-voltage torque wrench. Safe, sustainable and Made in Germany!
 ”

*Marcel - Product Management
 Interested in electro-mobility and renewable energies.*

5000KV Torque wrench

- Right/left release with plug-in square, thereby tightening at torque setting both to the right and to the left within the specified tolerance
- Can be readjusted and recalibrated
- Possible repairs for the torque wrenches in the HAZET Service Centre
- High durability
- Accuracy through the option of: Disassembly, adjustment, repair (if necessary), calibration, assembly
- Suitable for control of inspection and test equipment
- Sustainable and environmentally sound
- Fine scale graduation with vernier scale
- Locking against unintentional adjustment of the setting value
- Safe torque release: palpable (close-gap release), audible (“click” sound)
- Low weight for good handling and fatigue-free work
- DIN EN ISO 6789-2:2017, Square according to DIN 3120, ISO 1174-1, IEC 60900:2018

Germany **Made in Germany**

HAZET No.	No.	□	Torque range Nm	l mm	Release accuracy tolerance %	g	EAN-No. 4000896 +
5108KV	1	10 3/8	2 - 10	275	6	590	235421
5109KV	2	10 3/8	5 - 25	305	4	639	235445
5121KV	3	12 1/2	20 - 120	420	4	1470	233397

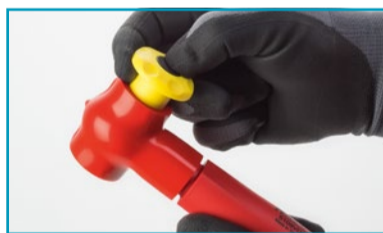

810/6VDE, EAN-No. 4000896179329

Tool set for electricians

- Ergonomically shaped HAZET 2-component handle (red/yellow)
 - Voltmeter (839-1), 220–250 V according to DIN VDE 06800-6
- Contents** (6-piece set):
- 810VDE
 - 839-1
 - 810VDE

- 0.4 x 2.5 · 0.6 x 3.5 · 0.8 x 4 mm
- 0.5 x 2.8 mm
- PH1 · PH2



150/39, EAN-No. 4000896239641

1/2" High voltage tool kit

- Universally applicable on all trucks and buses, as well as agricultural and construction machinery with electric drives
- For operation of live components such as batteries, capacitors or distributors
- The use of two extensions enables simple and safe installation and removal of e.g. the battery thanks to the special insulation of the tools
- All the relevant tools for the operation of live fittings in one set
- Highest level of safety through constant quality control of the tools
- Delivery in new HAZET L-Boxx 136 – all tools ready to hand
- For e-trucks from e.g.: **MERCEDES-BENZ, MAN, DAF, RENAULT, SCANIA** and **Volvo**
- Suitable for use with electric urban buses such as e.g. **MERCEDES-BENZ, MAN, VDL, IVECO, SOLARIS, Volvo, SCANIA, BYD, SILEO, LIKKER, COBUS, MELLOR, KARSAN, IRIZAR, EBUSCO, TEMSA, EURABUS, EASYMILE, NAVJA, LOCAL MOTORS, HEULIEZ**

12⁵ 1/2 12⁵ 1/2  39

















NEW!

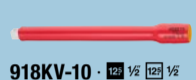

L-BOXX



L-Boxx 136

- | | | | |
|--|--|---|--|
| 
916KV · 12 ⁵ 1/2
Length: 260 mm | 
630KV · ●
s 13 · 17 · 19 mm | 
1804VDE-33
Length: 208 mm | 
1860VDE-11
Length: 160 mm |
| 
917KV-5 · 12 ⁵ 1/2 12 ⁵ 1/2
Length: 140 mm | 
450KV-5 · ●
s 13 · 17 · 19 mm | 
1802VDE-22
Length: 180 mm | 
1805VDE-44
Length: 200 mm |
| 
918KV-10 · 12 ⁵ 1/2 12 ⁵ 1/2
Length: 264 mm | 
810VDE · ●
0.4 x 2.5 · 0.5 x 3 ·
0.6 x 3.5 · 0.8 x 4 mm | 
1841AVDE-22
Length: 160 mm | 
2156VDE-2 |
| 
900KV · ● 12 ⁵ 1/2
s 13 · 14 · 15 · 16 ·
17 · 19 mm | 
810VDE · ●
PH1 · PH2 · PH3 | 
1816VDE-222
Length: 160 mm | 
196V-20/5 
196V-10/5 |

179NX-7/70KV, EAN-No. 4000896235483

Tool trolley *Assistant* with 70 expert high voltage tools

70

NEW!

2/3+			
------	--	--	--

1/3			
-----	--	--	--

 Made in Germany



Open-end wrench set · with protective insulation 163-542/18
● 450KV · 7 · 19 · 22 · 24 · 27 · 30 · 32 mm

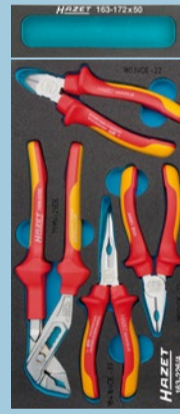

 Made in Germany
Soft foam insert with compartment for small pieces 163-172x50

Pliers set · with protective insulation 163-226/4
● 759N-2VDE · 1803VDE-22 · 1841BVDE-33 · 1850VDE-22



Socket set · with protective insulation 163-545/41
● 8816KV
● 8801K-KV · 5 · 6
● 8808LG-8 KV · 10 · 12
● 8821KV · 3 · 5
● 880KV · 6 · 20 · 22 mm
● 8802KV-T10 · 8802KV-LG · T15 · T20 · T25 · T27 · T30 · T40 · T45 · T50

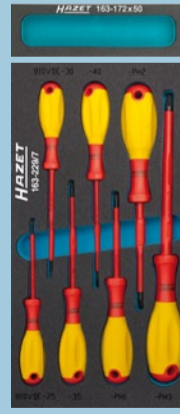

 Made in Germany
Soft foam insert with compartment for small pieces 163-172x50

Screwdriver set · with protective insulation 163-229/7
● 810VDE · 0.4 x 2.5 · 0.5 x 3 · 0.6 x 3.5 · 0.8 x 4 mm
● 810VDE-PH1 · PH2 · PH3



 Made in Germany
Tool trolley *Assistant* 179NX-7-RAL3020
Dimensions (L x W x H) 785 x 518 x 1,020 mm



Assortment

3/3+		
------	--	--



“

You can't do anything without light. That's why I think that HAZET lighting are some of their most varied and exciting products!

”

Niklas · Business Apprentice
Creates light in the darkest corners of engine compartments and his garage.



1979FC-60, EAN-No. 4000896227822

LED work spotlight 60 W

- Ideal work/building spotlight for illuminating dark building spaces
- Uniform room lighting:
Energy-efficient SMD LED technology
- Rotatable dimmer switch for infinite adjustment
- Robust PU housing with surrounding aluminium components for better heat dissipation
- Visual power indication: 4-stage
- Base: 90° adjustable
- Increased functionality by 2 additional 230 V sockets on the rear which enables coupling and operation of any additional devices
- Luminous flux: 600 – 6000 lumens
- Cable length: 5 m (H07RN) 3 x 1.5 mm²
- Protection rating: IP54



1979F-01,
EAN-No. 4000896227815

Light diffuser

- Attachment for better and homogeneous room illumination and for 360° light diffusion
- Attachment can be locked using a bayonet fitting



1979F-02,
EAN-No. 4000896227808

Magnetic holder

- Additional magnetic coating protects against damage to the substrates
- Locking mechanism using the enclosed fastening screw
- Magnetic retention force (max.): 10 kg



1979F-03,
EAN-No. 4000896227174

Telescopic tripod

- Tripod permits a secure stand on different surfaces
- Foot locking and height locking option
- Incl. additional cable guides on tripod
- Height (max.): 185 cm
- Height (min.): 120 cm
- Load-carrying capacity: 30 kg

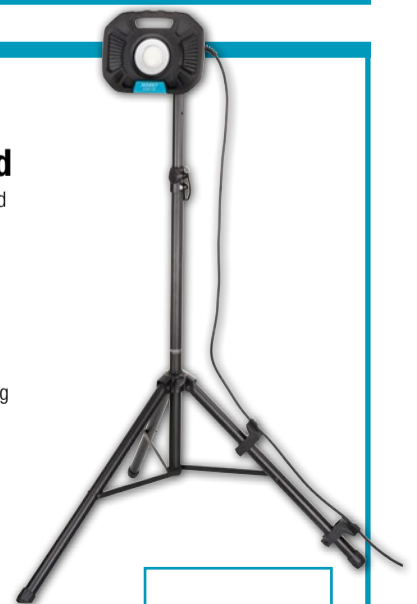

Delivery without work spotlight

Let there be light!



Splash resistant (IP54)



4-level power indicator



90° adjustable stand



Bayonet fitting for diffuser



1979N-71, EAN-No. 4000896208470

LED pen light

- Highly efficient reflector system
- Easily to operate while wearing working gloves
- LED technology: SMD
- Operating time: 4 hrs
- Power: 3 W
- Protection rating: IP54
- Impact resistance: IK07
- Length (total): 139 mm
- Incl. 2 x 1.5 volt batteries (AAA)



NEW!



1979N-72, EAN-No. 4000896208487

LED pen light

- Continuous one-hand focusing enables precise spotlight up to homogeneous floodlight
- LED technology: SMD
- Operating time (30/100%): 13/4.5 hrs
- Power: 3 W
- Protection rating: IP54
- Impact resistance: IK07
- Length (total): 135 mm
- Incl. 3 x 1.5 volt batteries (AAA)



NEW!



1979N-82,
EAN-No. 4000896227211

LED pocket light • USB-C

- Small design for use in areas with restricted access
- 180° adjustable and 8-step lockable base for adjustment of work area illumination
- Strong rubberised holding magnet on the bottom and back
- LED technology top light: SMD
- LED technology main light: COB
- Top light operating time: 5 hrs (100%)
- Main light operating time: 2–10 hrs/(10–100%)
- Top light power: 1 W
- Main light power: 3 W
- Charging time: 1.5 hrs
- Protection rating: IP65
- Impact resistance: IK09
- Dimensions (H x W x D): 133 x 65 x 33.8 mm
- Incl. 100 cm USB-C charging cable (without USB adapter)



NEW!



1979-11,
EAN-No. 4000896235254

LED pen light • USB-C

- Small compact LED light with high lighting power
- Progressively dimmable – optimal light adjustment
- Highly integrated holding magnets on the rear of the housing
- LED technology top light: SMD
- LED technology main light: COB
- Operating time: 2.5 hrs
- Top light power: 1 W
- Main light power: 2 W
- Protection rating: IP65
- Impact resistance: IK09
- Dimensions (H x W x D): 180 x 25 x 18 mm
- Incl. 100 cm USB-C charging cable (without USB adapter)



NEW!



1979W-11/3, EAN-No. 4000896235247

LED pen light set, wireless charging

- Contents:**
- 2 x 1979W-11 Pen Light
 - 1979WP-2 Charging pad for 2 lamps
 - Incl. 100 cm USB-C cable and 2 A/5V mains plugs



3



Incl. charging cable + plug adapter for the charging pad



1979NW/3, EAN-No. 4000896235261

LED inspection lamp set, wireless charging

- Contents:**
- 1979W-11 Pen light
 - 1979W-82 Pocket Light
 - 1979WP-2 Charging pad for 2 lamps
 - Incl. 100 cm USB-C cable and 2 A/5V mains plugs



3



Incl. charging cable + plug adapter for the charging pad



HIGH-TECH BORESCOPE IN COMPACT DESIGN

Comparison: Display resolution of current probe (left) with new probe



320 x 240 pixels



800 x 480 pixels

Zoom: 3-step



5 inch display readable in sunlight

Touch display



Easy to handle

Video borescope

- Display resolution: 800 x 480 pixels
- 8-level brightness setting (5 + 3 boost)
- Display of battery capacity
- Timestamp can be shown
- Record photos and videos
- Mirroring and negative display of the camera image possible
- Photo designation possible
- Data transfer: USB-C
- Charger: USB charging adapter DC-5 V/3 A

High-tech borescope in compact design!



Can swivel to any position



Swivelling magnetic base, 180° adjustable



HDMI port for video output, USB-C for charging, Micro SD



With a practical mount



The recessed plug is protected against damage

4812-21/5S, EAN-No. 4000896238811

Borescope set with semi-flexible probe Ø 5.5 mm

- Improved accuracy of detail thanks to micro lens Ø 5.5 mm
- Front camera: 0°
- Image resolution: 1,024 x 768 px
- Focus range: 10 to 60 mm
- Focus angle: 56°
- Probe cable: 1,000 mm
- 4-way LED luminous source

Contents:

- Basic unit 4812-21
- Probe 4812-21S
- USB-C to USB-A cable
- Aluminium case

Easy to read, even in sunlight!



NEW!



4812-21S, EAN-No. 4000896237623

Semi flexible probe - Ø 5.5 mm

- Optimally suited to the basic unit 4812-21
- Improved accuracy of detail thanks to micro lens Ø 5.5 mm
- Front camera: 0°
- Focus range: 10-60 mm



4812-21/5AF, EAN-No. 4000896239283

Borescope set with swivelling probe Ø 4.5 mm

- Up to 180° swivel on both sides enables e.g. a real reverse view onto valves in the cylinder head
- Compatible with basic unit 4812-21
- Bending radius only approx. 38 mm (-30 % compared to conventional designs)
- Improved accuracy of detail thanks to micro lens Ø 4.5 mm
- Front camera
- Image resolution: 1,024 x 768 px
- Focus range: 10-100 mm
- Focus angle: 90°
- Probe cable: 1,000 mm
- 5-way LED luminous source

Contents:

- Basic unit 4812-21
- Probe 4812-21AF
- USB-C to USB-A cable
- L-Boxx 136

Easy to handle!



NEW!



4812-21AF, EAN-No. 4000896237630

Swivelling probe 180° · Ø 4.5 mm

- Optimally suited to the basic unit 4812-21
- Improved accuracy of detail thanks to micro lens Ø 4.5 mm
- Full swivel up to 180° on both sides enables e.g. a real reverse view onto valves in the cylinder head
- Focus range: 10-100 mm

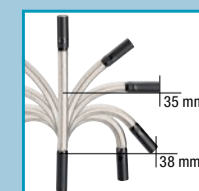



HiPer (HP) Fine-tooth reversible ratchet



Made in Germany

HAZET No.	□	Nm	l mm	EAN-No. 4000896 +
863HPB	6.3 1/4	120	116	235346
863HP	10 3/8	120	116	226917
8816HP	12 1/2	400	200	235063
916HP	12 1/2	1000	275	213894
916HPL	12 1/2	1000	415	219209
916HPLG	12 1/2	1000	414-614	233076

HiPer
HIGH PERFORMANCE
THE ORIGINAL
MADE IN GERMANY



HiPer (HPS) Fine-tooth reversible ratchet with safety locking

- Loosening-proof locking thanks to pushbutton actuation
- Attached tools are easily released by pressing the button with just one hand

Made in Germany

HAZET No.	□	Nm	l mm	EAN-No. 4000896 +
863HPS	6.3 1/4	62	116	237234
8816HPS	10 3/8	340	200	237241
916HPS	12 1/2	850	275	237258



HiPer
HIGH PERFORMANCE
THE ORIGINAL
MADE IN GERMANY

1005S 3/4" Impact extension

- With borehole for locking pin or safety spring and groove for o-ring
- Surface: phosphatized, oiled
- For impact operation
- DIN 3121

Made in Germany

HAZET No.	l mm	g	EAN-No. 4000896 +
1005S-7	175	0.82	001774
1005S-13	330	1.30	001767



1000, EAN-No. 4000896000616 3/4" Socket set

- Sheet metal box (HAZET blue)
- Soft foam insert
- Dimensions (L x W x H): 578 x 235 x 88 mm



1000 · 20 3/4	1015-1 · 20 3/4	1017-8 · 20 3/4 · 20 3/4
22 · 24 · 27 · 30 · 32		
36 · 38 · 41 · 46 · 50 mm		
1014	1016 · 20 3/4	1018 · 20 3/4 · 20 3/4

Made in Germany

1105S Impact extension

- With borehole for locking pin or safety spring and groove for o-ring
- Surface: phosphatized, oiled
- DIN 3121

Made in Germany

HAZET No.	l mm	g	EAN-No. 4000896 +
1105S-7	180	1.34	002702
1105S-13	330	2.17	002696



1100SLG 1" Impact socket (6-point)

- Long design
- With borehole for locking pin or safety spring and groove for o-ring
- Surface: phosphatized, oiled
- DIN 3129, ISO 2725-2

Made in Germany

HAZET No.	l mm	d ₁ mm	d ₂ mm	f mm	EAN-No. 4000896 +
1100SLg-24	110	41.5	54	17	002405
1100SLg-27	110	45.0	54	19	002412
1100SLg-30	110	49.0	54	21	002429
1100SLg-32	110	51.5	54	21	002436
1100SLg-33	110	52.5	54	21	002443
1100SLg-36	110	56.5	54	23	002467
1100SLg-38	110	59.0	54	24	002474
1100SLg-41	110	63.0	54	26	002481
1100SLg-46	110	69.5	54	28	002498

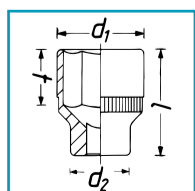

1100Z, EAN-No. 4000896002504 1" Socket set

- With 12-point sockets
- Sheet metal box (HAZET blue)
- Dimensions (L x W x H): 759 x 305 x 115 mm

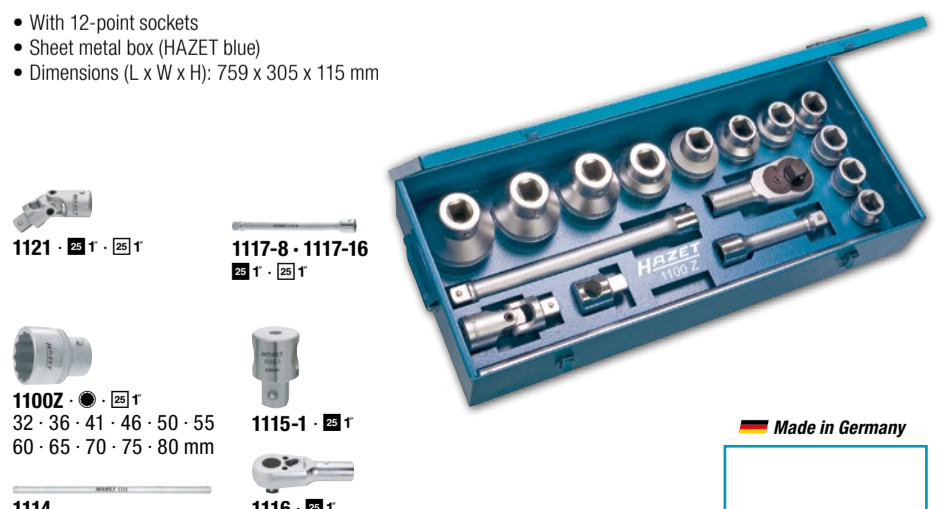

1121 · 25 1"	1117-8 · 1117-16
	23 1" · 25 1"
1100Z · 25 1"	1115-1 · 25 1"
32 · 36 · 41 · 46 · 50 · 55	
60 · 65 · 70 · 75 · 80 mm	
1114	1116 · 25 1"

Made in Germany





“

What should stand between you and the tree? Just an axe with specially sanded axe head and slip-resistant handle!

”

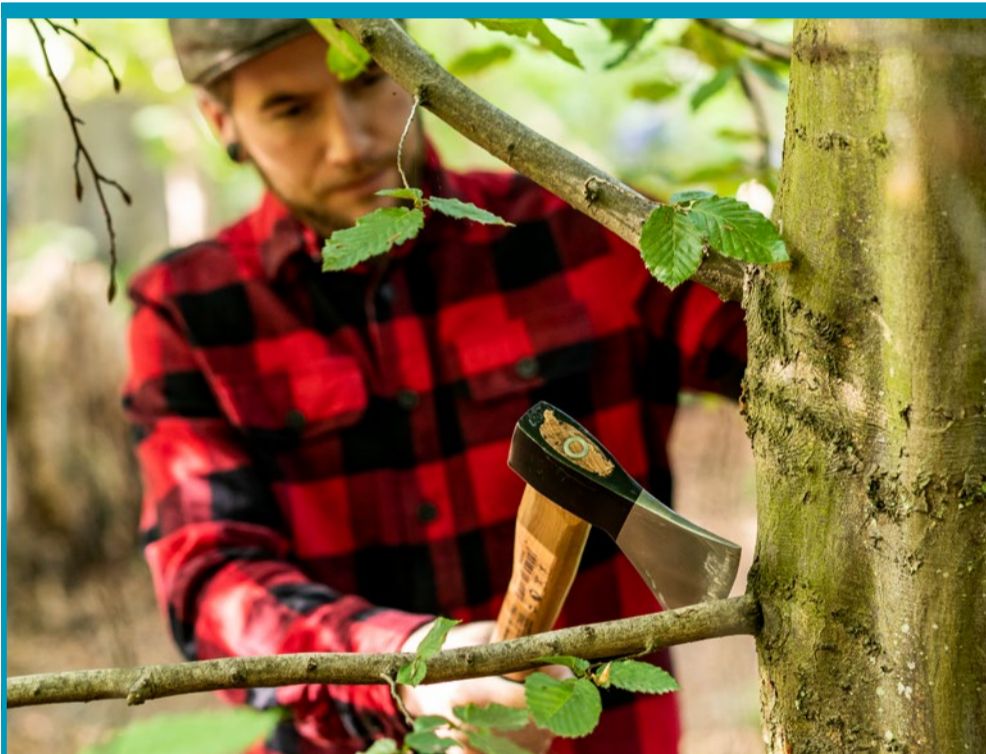
*Marcel - Product Management
Cuts firewood in his spare time for his home fireplace.*



2132-600, EAN-No. 4000896231140

Hand axe

- Handy helper, especially suitable for splitting firewood and cutting off small branches
- Tool head and tool handle with double safety wedging
- Incl. silicon cutting guard
- Cutting width: 105 mm
- Handle length: 360 mm
- Weight (net): 600 g



Versatile!



Made in Germany



2132-3, EAN-No. 4000896244607

Pickaroon

NEW!

- Allows logs to be safely moved and lifted
- Ergonomically shaped handle sits comfortably in the hand
- Handle made of genuine USA hickory wood, without defects or splinters
- Use for forestry work in the woods or for working firewood
- Professional double wedging between tool head and handle
- Especially suitable for continuous operation by professionals
- Incl. rubber protective sleeve
- Handle length: 400 mm
- Weight (net): 550 g



Moving wood made easy!

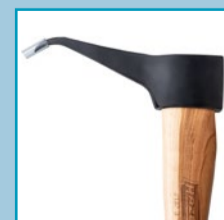



2134-1250, EAN-No. 4000896229529

Riving axe

- High splitting effect due to optimised head shape
- Hollow forged spreading wedges prevent the axe from jamming in the wood
- Impact protection sleeve to increase the service life in case of mishits
- Incl. leather blade guard
- Cutting width: 92 mm
- Handle length: 500 mm
- Weight (net): 1,250 g



Easier splitting thanks to spreading wedges!



Made in Germany

2133-1250, EAN-No. 4000896231133

Wood axe

- Tool head and tool handle with triple safety wedging
- To increase service life, the handle is specially protected by an impact protection sleeve in case of failure
- Incl. silicon cutting guard
- Cutting width: 132 mm
- Handle length: 700 mm
- Weight (net): 1,250 g



Suitable for continuous professional operation!



Made in Germany

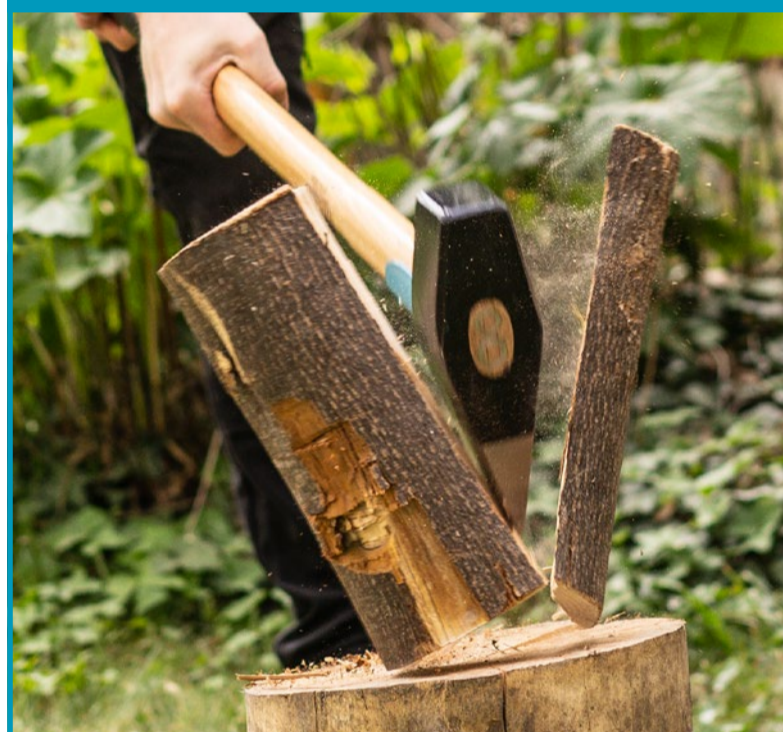

2135-3000, EAN-No. 4000896231157

Sledgehammer

- Very well suited for tearing up metre-long pieces and driving aluminium wedges into wood
- Easy penetration into the wood due to specially polished cutting edge (lamella grinding technique)
- Ergonomically shaped genuine USA hickory wood handle with non-slip grip end
- Impact protection sleeve to increase durability in case of misses (safety wedging)
- Incl. leather blade guard
- Cutting width: 75 mm
- Handle length: 900 mm
- Weight (net): 3,000 g



Stable striking face!



Made in Germany



2132-1, EAN-No. 4000896244805

Aluminium felling wedge - straight

- Ideal for felling trees or ripping logs
- Conical design makes for easy cutting into wood as well as simple felling and targeted work on trees
- Forged aluminium wedge is lightweight and shatterproof
- High handling comfort thanks to light weight of only 550 g

NEW!

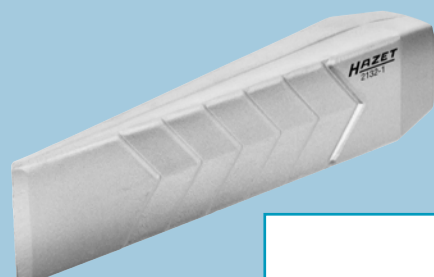

2132-2, EAN-No. 4000896244799

Aluminium splitting wedge - rotated

- The rotated, conical shape of the splitting wedge allows for easy, targeted penetration into wood and log splitting
- Especially suitable for continuous operation by professionals
- Forged aluminium wedge is lightweight and shatterproof
- High handling comfort thanks to light weight of only 800 g

NEW!



Newer! Deeper! Better! Contains more!

179NXXL-8D/619, EAN-No. 4000896245185 619

Tool trolley *Assistent*
with 616 expert tools,
lateral door and
multiple socket strip

H x W x D: 1,020 x 1,133 x 642 mm

- More drawer space for tools due to greater drawer depth!
- Much larger storage and work areas made from stainless steel!
- 7 flat drawers (81 x 870 x 522 mm) and one high drawer (166 x 870 x 522 mm)
- 100% drawer slide-out with ball-bearing telescopic slides
- Loading capacity per drawer: 40 kg

NEW!



Made in Germany
Tool trolley *Assistent*
179NXXL-8D

With lateral door HAZET 179N-21D and multiple socket strip HAZET 161N-5D

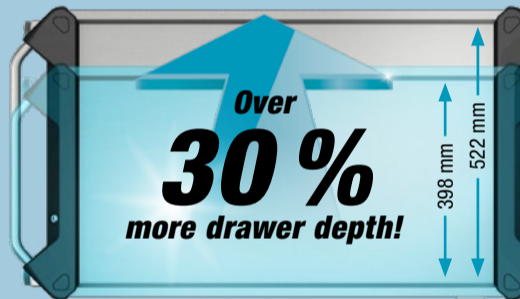

Drawer depth comparison: 179NXXL-8D (522 mm) with 179N series (398 mm)



163D-1/148
1/8 3/16 1/4 5/16 3/8 7/16 1/2 5/8 3/4 7/8 1

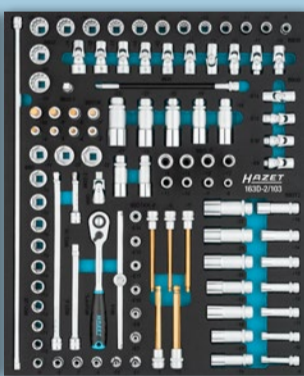

163D-2/103
10 9/16 10 3/8 11 1/8 1 1/4 1 1/2 1 3/4 2 1/4 3

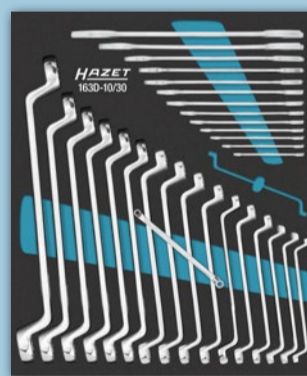

163D-10/30
5 5x5,5 – 34x36 mm
6 6x7 – 36x41 mm



163D-9/42
8 8 – 32 mm
9 5,5 – 32 mm

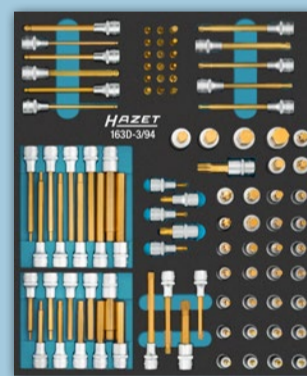

163D-3/94
3/8 1/4 1/2 3/4 1 1 1/4 1 1/2 2 2 1/4 3 3 1/2 4 5 6 8 10 12 15 20 25 30 36 42 48 54 60 66 72 78 84 90 96 102 108 114 120 126 132 138 144 150 156 162 168 174 180 186 192 198 204 210 216 222 228 234 240 246 252 258 264 270 276 282 288 294 300 306 312 318 324 330 336 342 348 354 360 366 372 378 384 390 396 402 408 414 420 426 432 438 444 450 456 462 468 474 480 486 492 498 504 510 516 522 528 534 540 546 552 558 564 570 576 582 588 594 600 606 612 618 624 630 636 642 648 654 660 666 672 678 684 690 696 702 708 714 720 726 732 738 744 750 756 762 768 774 780 786 792 798 804 810 816 822 828 834 840 846 852 858 864 870 876 882 888 894 900 906 912 918 924 930 936 942 948 954 960 966 972 978 984 990 996



163D-4/44
1/2 3/4 1 1 1/4 1 1/2 2 2 1/4 3 3 1/2 4 5 6 8 10 12 15 20 25 30 36 42 48 54 60 66 72 78 84 90 96 102 108 114 120 126 132 138 144 150 156 162 168 174 180 186 192 198 204 210 216 222 228 234 240 246 252 258 264 270 276 282 288 294 300 306 312 318 324 330 336 342 348 354 360 366 372 378 384 390 396 402 408 414 420 426 432 438 444 450 456 462 468 474 480 486 492 498 504 510 516 522 528 534 540 546 552 558 564 570 576 582 588 594 600 606 612 618 624 630 636 642 648 654 660 666 672 678 684 690 696 702 708 714 720 726 732 738 744 750 756 762 768 774 780 786 792 798 804 810 816 822 828 834 840 846 852 858 864 870 876 882 888 894 900 906 912 918 924 930 936 942 948 954 960 966 972 978 984 990 996

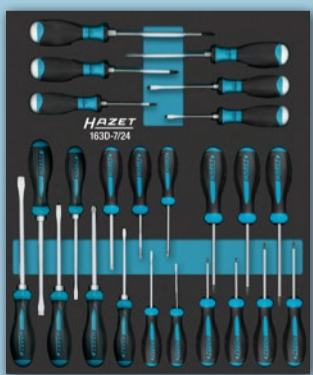

163D-7/24
7



163D-6/53
6

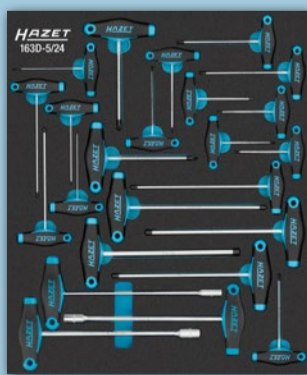

163D-5/24
5



163D-12/30
12



163D-11/11
11



163D-8/13
8

Tool trolley or workbench: Your decision!

179NW-8/244, EAN-No. 4000896223046 244

**Work bench *Assistent*[®]
with assortment**

H x W x D: 964 x 1,150 x 600 mm

**244 professional tools!
7 filled drawers!**

179NX-8/244, EAN-No. 4000896223039 244

**Tool trolley *Assistent*[®]
with assortment**

H x W x D: 1,020 x 786 x 518 mm



 **Made in Germany**
**Work bench
Assistent[®]
179NW-8**



 **Made in Germany**
**Tool trolley
Assistent[®]
179NX-8**

**Either
or?**



Soft foam insert with compartments for small pieces 163-522x50 (5x)



**Socket/screwdriver set
163-224/57**
 Ⓞ Ⓞ Ⓞ Ⓞ Ⓞ 1/2 3/4 1 1 1/4
 s 5.5–13 mm · 1/8 s 10–32 mm
**Socket set
163-181/17**
 1/8 s 10–22 mm



**Tool set
163-211/20**
 Ⓞ s 8 x 9–34 x 36 mm ·
 Ⓞ T60, T80, T100 ·
 Ⓞ s 14, 17, 19, 22 mm
**Double box-end wrench set
163-296/7**
 Ⓞ s 6 x 7–21 x 22 mm

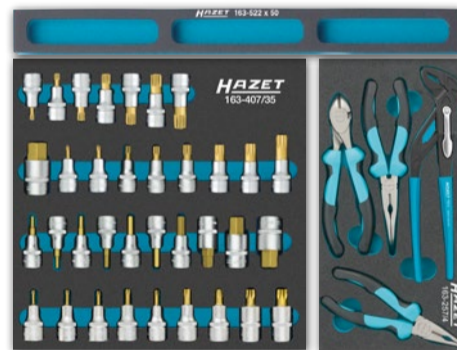

**Screwdriver socket set
163-407/35**
 1/2 Ⓞ s 5–22 mm ·
 Ⓞ M5–M18 mm · Ⓞ T20–T60
**Pliers set
163-257/4**

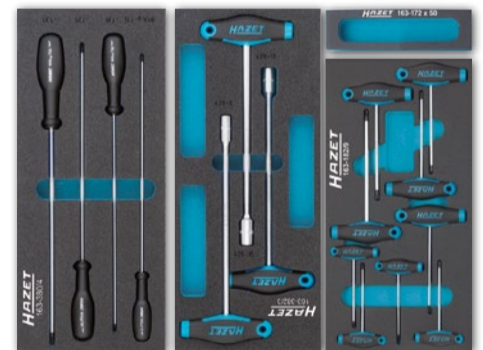

TORX[®] screwdriver set 163-380/4
 Ⓞ T15–T30
Socket set 163-382/3
 Ⓞ s 8, 10, 13 mm
TORX[®] screwdriver set 163-182/9
 Ⓞ T6–T30
**Soft foam insert with compartment for
small pieces 163-172x50**



**Screwdriver set
163-297/26**
 Ⓞ Ⓞ Ⓞ Ⓞ
**Ratcheting combination wrench
set 163-385/12**
 Ⓞ s 8–19 mm



**Combination wrench set
163-210/19**
 Ⓞ s 8–34 mm



**Universal set
163-372/25**

0-179/244, EAN-No. 4000896204236 244

**Tool assortment,
individual**
 • 244 expert tools

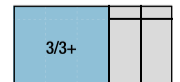

Organisation is the first step to everything!

179NX-8/206, EAN-No. 4000896239375

Tool trolley *Assistant* with 206 expert tools

206



Made in Germany

Tool trolley *Assistant*

179NX-8

Dimensions (L x W x H) 786 x 518 x 1,020 mm

3/3+



Tool set
163-535/18

2-8 mm
2-4 mm

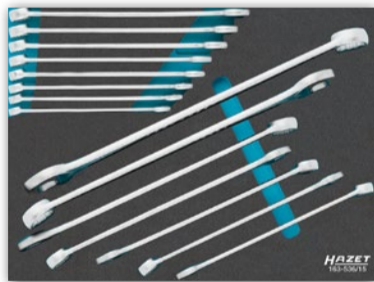

Combination wrench set
163-536/15

s 10-30 mm, long



Screwdriver set
163-297/26

Circclip pliers set
163-531/4



Screwdriver socket set
163-534/37

s 5-22 mm, short
s 5-10 mm, long
s 8-18 mm
T20-T60



Tool set
163-533/20

s 8-24 mm
1/2 10-60 Nm, 40-200 Nm



Socket set
163-224/57

Pliers set
163-511/4

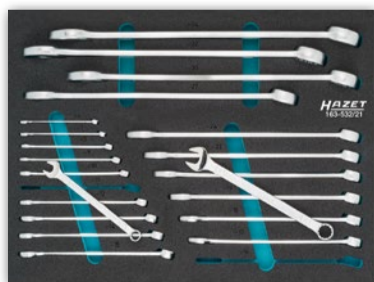

Combination wrench set
163-532/21

s 6-34 mm



Impact adapter 1007S-7/4

With replaceable 1/2 plug-in blades

**206 professional tools!
8 filled drawers!**

Your HAZET specialist dealer



NKW22/EN/XX/0/1. 02.22/1.2 CHS/MD